

Moulding & Millwork

The Builder's preference for innovative ideas and superior quality.



Moulding Selection Guide

2006 Mid Atlantic Edition

MOULDING & MILLWORK

Casings

Casings define the overall character of a room and are often the most visible part of the trim. Casings are used primarily to cover the gap between drywall and the door or window frame. Casings are generally thicker than the base mouldings.

ALL SIZES NOMINAL

M&M#	WM#	Feather Edge	Ln.Ft.	BDL
361WW	L361	11/16" x 4-1/2" Solid Pine	RL	8

M&M#	WM#	Feather Edge	Ln.Ft.	BDL
361W	L361	11/16" x 3-1/2" Solid Pine	RL	10
361WFJ	L361	11/16" x 3-1/2" Finger Joint	16'	10
361LP	L361	11/16" x 3-1/2" Primed FJ	16'	10
361WP	L361	11/16" x 3-1/2" Primed FJ	16'	10

M&M#	WM#	Feather Edge	Ln.Ft.	BDL
366	366	11/16" x 2-1/4" Solid Pine	RL	12
366FJ	366	11/16" x 2-1/4" Finger Joint	14'	12
366P	366	11/16" x 2-1/4" Primed FJ	14'	12
366O	366	5/8" x 2-1/4" Oak	RL	12
366M	366	15mm x 2-1/4" Ultralite MDF	14'	12

Solid Pine, Oak, Finger Joint & Primed FJ available in 7' legs

M&M#	WM#	Feather Edge	Ln.Ft.	BDL
366M	366	9/16" x 2-1/4" Ultralite MDF	14'	12

M&M#	WM#	Feather Edge	Ln.Ft.	BDL
331	331	11/16" x 2-1/2" Solid Pine	RL	12
331W	331	11/16" x 3-1/2" Solid Pine	RL	10

M&M#	WM#	Ln.Ft.	BDL
003M		11/16" x 3-1/4" Ultralite MDF	15' 6

M&M#	WM#	Feather Edge	Ln.Ft.	BDL
361	361	11/16" x 2-1/2" Solid Pine	RL	12
361FJ	361	11/16" x 2-1/2" Finger Joint	14'	12
361P	361	11/16" x 2-1/2" Primed FJ	14'	12
361O	361	5/8" x 2-1/2" Oak	RL	12
361M	361	5/8" x 2-1/2" Ultralite MDF	14'	12

Solid Pine & Primed FJ available in 7' legs

M&M#	WM#	Feather Edge	Ln.Ft.	BDL
361WM	361	5/8" x 3-1/2" Ultralite MDF	15'	6

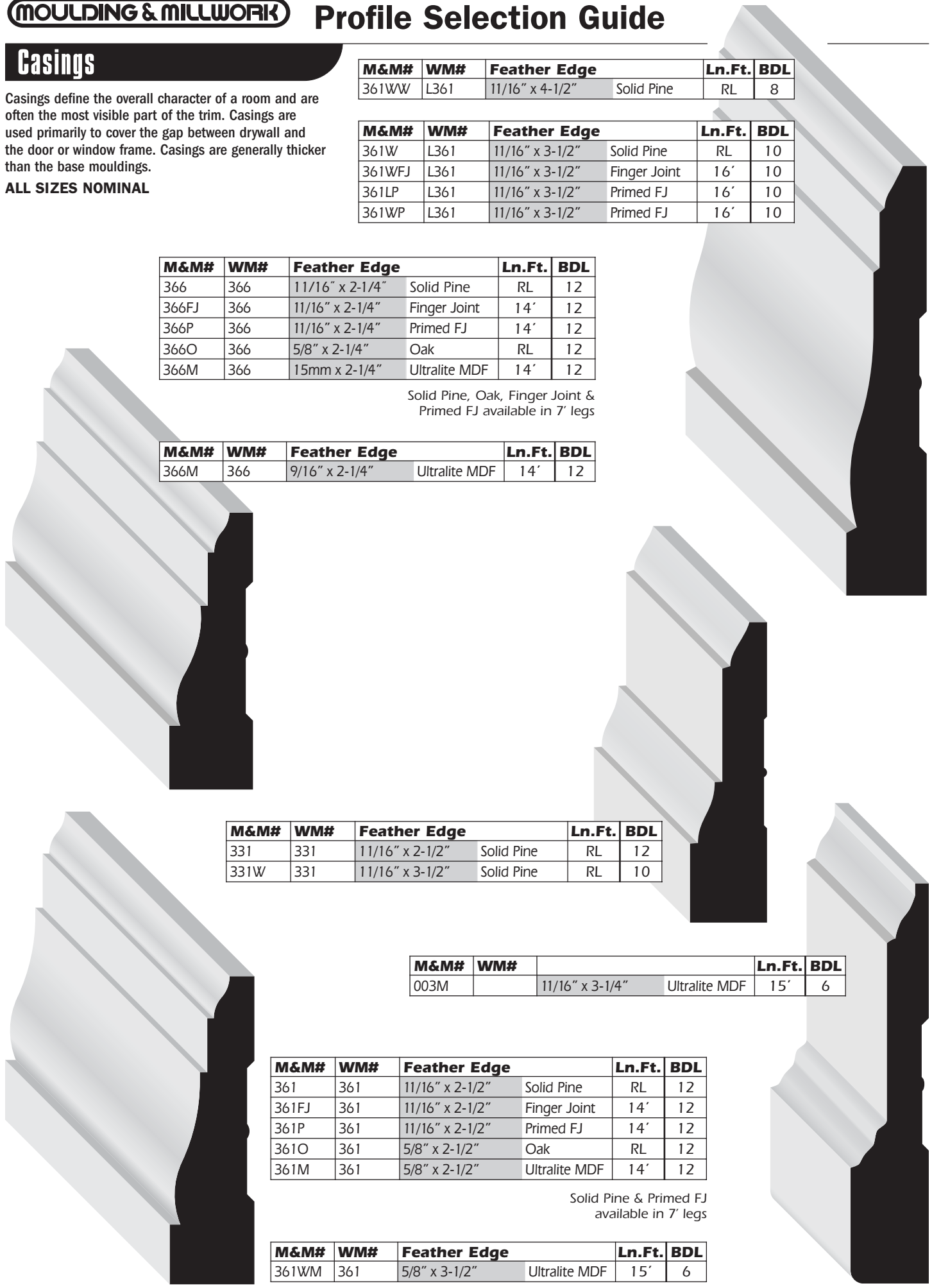

Casings

Casings define the overall character of a room and are often the most visible part of the trim. Casings are used primarily to cover the gap between drywall and the door or window frame. Casings are generally thicker than the base mouldings.

ALL SIZES NOMINAL

M&M#	WM#	Colonial Beaded	Ln.Ft.	BDL
445	445	11/16" x 3-1/4" Solid Pine	RL	10
445FJ	445	11/16" x 3-1/4" Finger Joint	16'	10
445P	445	11/16" x 3-1/4" Primed FJ	16'	10
445O	445	5/8" x 3-1/4" Oak	RL	10
445M	445	15mm x 3-1/4" Ultralite MDF	15'	10
445LM	445	3/4" x 3-1/4" Ultralite MDF	16'	6

Solid Pine, Finger Joint & Primed FJ available in 7'3" legs

M&M#	WM#	Colonial Beaded	Ln.Ft.	BDL
376	376	11/16" x 2-1/4" Solid Pine	RL	12
376FJ	376	11/16" x 2-1/4" Finger Joint	14'	12
376P	376	11/16" x 2-1/4" Primed FJ	14'	12
376O	376	5/8" x 2-1/4" Oak	RL	12
376M	376	15mm x 2-1/4" Ultralite MDF	14'	12

All above 376 species available in 7' legs

M&M#	WM#	Colonial Beaded	Ln.Ft.	BDL
371	371	11/16" x 2-1/2" Solid Pine	RL	12
371P	371	11/16" x 2-1/2" Primed FJ	14'	12

M&M#	WM#	Colonial Beaded	Ln.Ft.	BDL
370P	370	11/16" x 2-3/4" Primed FJ	15'	12

M&M#	WM#	Feather Edge	Ln.Ft.	BDL
351	351	11/16" x 2-1/2" Solid Pine	RL	12

M&M#	WM#	Colonial Beaded	Ln.Ft.	BDL
99	99	11/16" x 3-1/2" Solid Pine	RL	8
99P	99	11/16" x 3-1/2" Primed FJ	16'	8
99O	99	11/16" x 3-1/2" Oak	RL	8

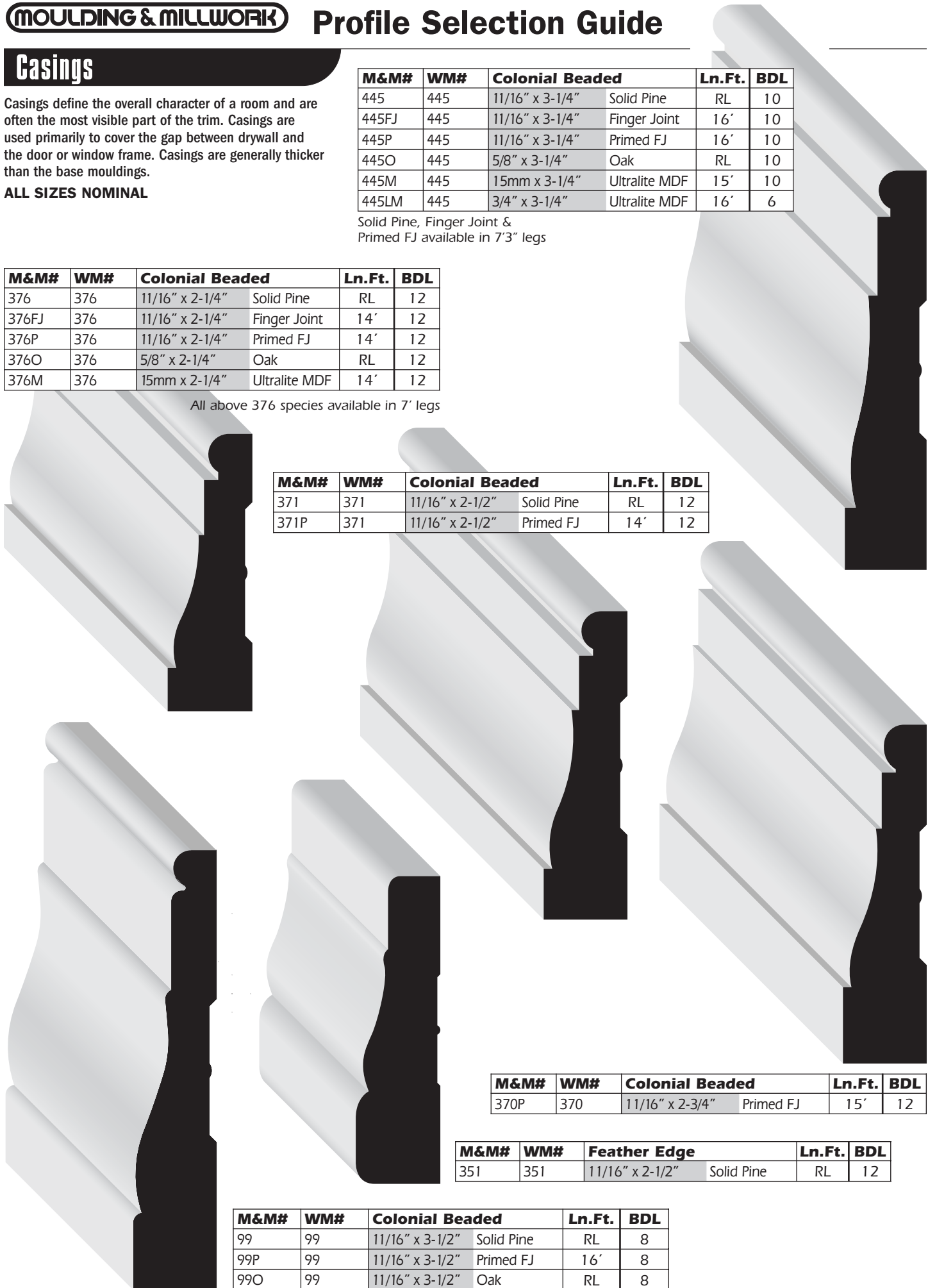

Casings

Casings define the overall character of a room and are often the most visible part of the trim. Casings are used primarily to cover the gap between drywall and the door or window frame. Casings are generally thicker than the base mouldings.

ALL SIZES NOMINAL

M&M#	WM#	Sanitary R2E	Ln.Ft.	BDL
412P	412	11/16" x 3-1/2" Primed FJ	16'	10
412ZP	412	11/16" x 3-1/2" Primed FJ	16'	10

M&M#	WM#	Sanitary R2E	Ln.Ft.	BDL
472	472	9/16" x 2-1/2" Solid Pine	RL	12
472P	472	9/16" x 2-1/2" Primed FJ	14'	12

M&M#	WM#	Sanitary R1E	Ln.Ft.	BDL
452L	452	11/16" x 2-1/2" Solid Pine	RL	12
452ZP	452	11/16" x 2-1/2" Primed FJ	16'	12

M&M#	WM#	Sanitary R2E	Ln.Ft.	BDL
452	452	11/16" x 2-1/2" Solid Pine	RL	12
452P	452	11/16" x 2-1/2" Primed FJ	14'	12

M&M#	WM#	Sanitary R1E	Ln.Ft.	BDL
432Z	432	9/16" x 3-1/2" Solid Pine	RL	8

M&M#	WM#	Sanitary R2E	Ln.Ft.	BDL
433	433	9/16" x 3-1/4" Solid Pine	RL	10

M&M#	WM#	Sanitary R2E	Ln.Ft.	BDL
432	432	9/16" x 3-1/2" Solid Pine	RL	8
432P	432	9/16" x 3-1/2" Primed FJ	15'	8

Casings

Casings define the overall character of a room and are often the most visible part of the trim. Casings are used primarily to cover the gap between drywall and the door or window frame. Casings are generally thicker than the base mouldings.

ALL SIZES NOMINAL

M&M#	WM#	Coxcomb	Ln.Ft.	BDL
522P		1-1/8" x 3-1/2" Primed FJ	16'	6

Primed FJ available in 7'4" legs

M&M#	WM#	Architrave	Ln.Ft.	BDL
523M		25mm x 3-1/2" Ultralite MDF	16'	4
523		1-1/16" x 3-1/2" Solid pine	RL	6
523P		1-1/16" x 3-1/2" Primed FJ	16'	6
523FJ		1-1/16" x 3-1/2" Finger Joint	16'	6

M&M#	WM#	Casing	Ln.Ft.	BDL
446M		5/8" x 3-1/2" Ultralite MDF	15'	8

M&M#	WM#	Adams	Ln.Ft.	BDL
97	97	1-1/16" x 3-1/2" Solid Pine	RL	6
97FJ	97	1-1/16" x 3-1/2" Finger Joint	16'	6
97LFJ	L97	7/8" x 3-1/2" Finger Joint	16'	8
97P	97	1-1/16" x 3-1/2" Primed FJ	16'	6
PVC97	97	1-1/32" x 3-1/2" PVC	16'	8
PVC97S	L97	7/8" x 3-1/2" PVC	16'	8
97M	97	25mm x 3-1/2" Ultralite MDF	16'	4

Finger Joint, Primed FJ & L97 Finger Joint available in 7'4" legs

M&M#	WM#	Casing	Ln.Ft.	BDL
139M		1-3/16" x 3-3/4" Ultralite MDF	16'	2

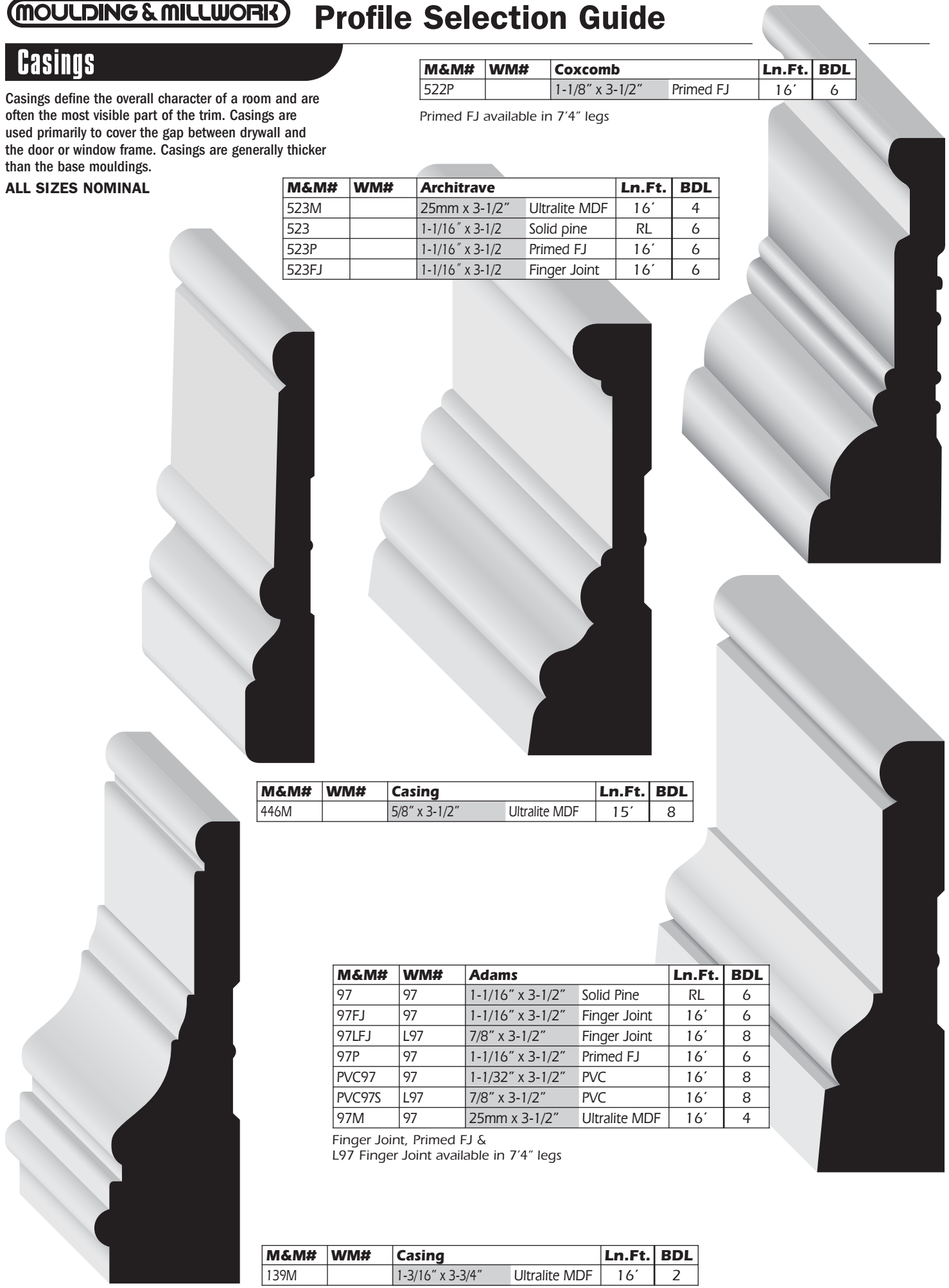

Casings

Casings define the overall character of a room and are often the most visible part of the trim. Casings are used primarily to cover the gap between drywall and the door or window frame. Casings are generally thicker than the base mouldings.

ALL SIZES NOMINAL

M&M#	WM#	Casing		Ln.Ft.	BDL
9753M		1 1/16" x 4-1/2"	Ultralite MDF	16'	

M&M#	WM#	Casing		Ln.Ft.	BDL
970M		1 1/16" x 3-1/2"	Ultralite MDF	16'	

M&M#	WM#	Casing		Ln.Ft.	BDL
470FJ	470	1-1/16" x 3-11/16"	Finger Joint	15'	6

Available in 7' legs

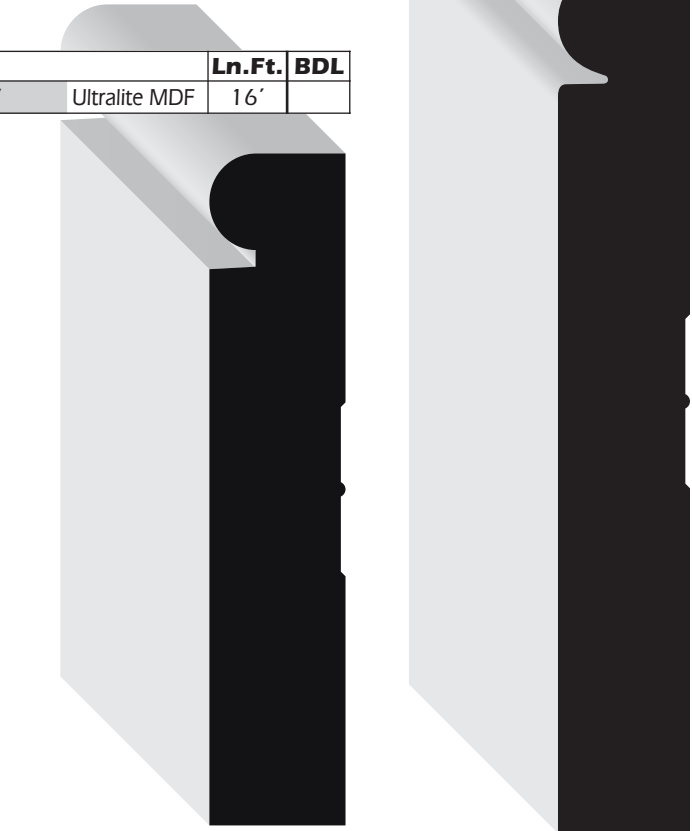

M&M#	WM#	Casing		Ln.Ft.	BDL
444L	444	1 1/16" x 3-1/4"	Solid Pine	RL	10
444LFJ	444	1 1/16" x 3-1/4"	Finger Joint	15'	10
444O	444	5/8" x 3-1/2"	Red Oak	RL	8
444	444	1 1/16" x 3-1/2"	Solid Pine	RL	10
444M	444	3/4" x 3-1/2"	Ultralite MDF	15'	6

M&M#	WM#	Casing		Ln.Ft.	BDL
442	442	1 1/16" x 2-1/4"	Solid Pine	RL	12
442M	442	15mm x 2-1/4"	Ultralite	14'	12
442FJ	442	1 1/16" x 2-1/4"	Finger Joint	14'	12

Finger Joint available in 7' legs

M&M#	WM#	Colonial		Ln.Ft.	BDL
356	356	1 1/16" x 2-1/4"	Solid Pine	RL	12
356FJ	356	1 1/16" x 2-1/4"	Finger Joint	14'	12
356P	356	1 1/16" x 2-1/4"	Primed FJ	14'	12
356XO	356	5/8" x 2-1/4"	Oak	RL	12
356M	356	15mm x 2-1/4"	Ultralite MDF	14'	12

All above 356 species available in 7' legs

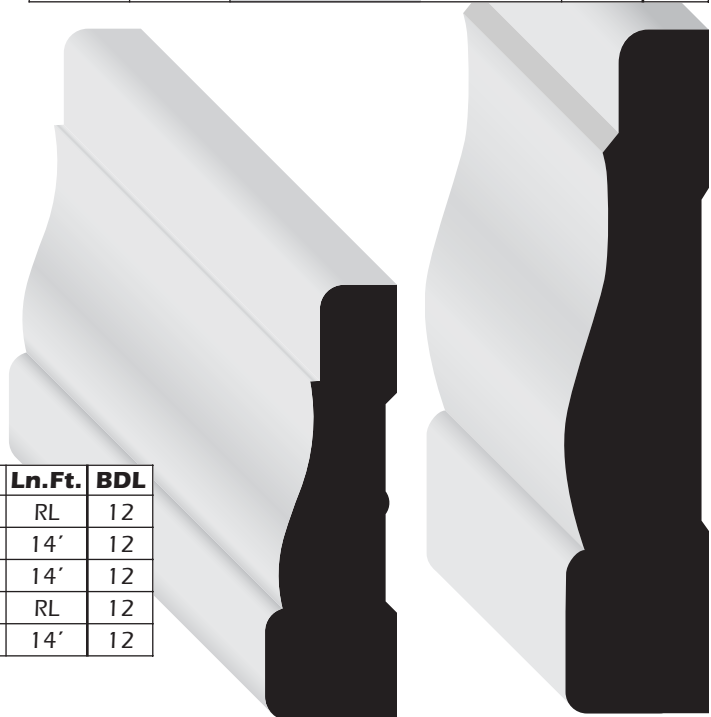

Casings

Casings define the overall character of a room and are often the most visible part of the trim. Casings are used primarily to cover the gap between drywall and the door or window frame. Casings are generally thicker than the base mouldings.

ALL SIZES NOMINAL

M&M#	WM#	Casing	Ln.Ft.	BDL
441WM		1-1/16" x 4-1/2" Ultralite MDF	16'	4

M&M#	WM#	Casing	Ln.Ft.	BDL
325M		1-1/16" x 2-1/2" Ultralite MDF	15'	8



M&M#	WM#	Casing	Ln.Ft.	BDL
441M		1-1/16" x 3-1/8" Ultralite MDF	16'	4

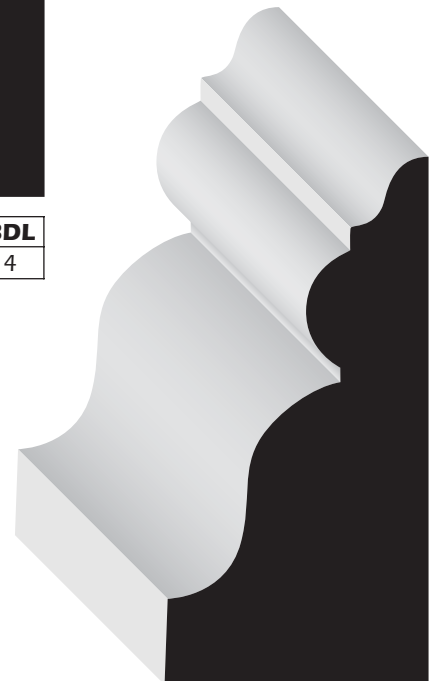

M&M#	WM#	Casing	Ln.Ft.	BDL
3122M		1-1/16" x 3-1/2" Ultralite MDF	16'	8

M&M#	WM#	Casing	Ln.Ft.	BDL
9083M		1-3/8" x 2-3/4" Ultralite MDF	15'	4

Casings

Casings define the overall character of a room and are often the most visible part of the trim. Casings are used primarily to cover the gap between drywall and the door or window frame. Casings are generally thicker than the base mouldings.

ALL SIZES NOMINAL

M&M#	WM#	Contemporary	Ln.Ft.	BDL
795		11/16" x 2-1/4" Solid Pine	RL	

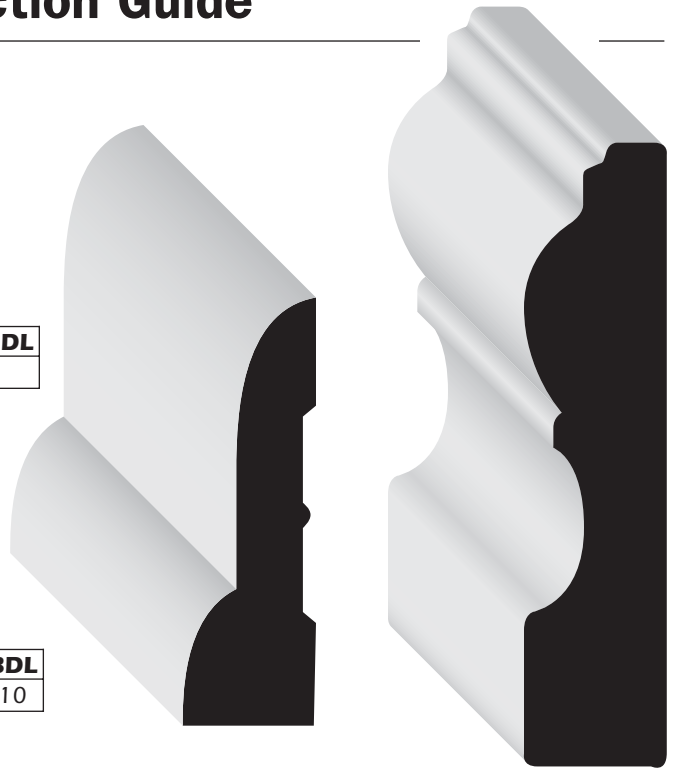

M&M#	WM#	Contemporary	Ln.Ft.	BDL
714		9/16" x 3" Solid Pine	RL	10



M&M#	WM#	Heritage	Ln.Ft.	BDL
8063M	8063	18mm x 3-1/4" Ultralite MDF	16'	6



M&M#	WM#	Colonial	Ln.Ft.	BDL
411M		18mm x 3" Ultralite MDF	16'	6

M&M#	WM#	Contemporary	Ln.Ft.	BDL
535M		18mm x 3-1/2" Ultralite MDF	16'	12

M&M#	WM#	Casing	Ln.Ft.	BDL
9053M		1" x 4-1/2" Ultralite MDF	16'	2

Casings

Casings define the overall character of a room and are often the most visible part of the trim. Casings are used primarily to cover the gap between drywall and the door or window frame. Casings are generally thicker than the base mouldings.

ALL SIZES NOMINAL

M&M#	WM#	Casing	Ln.Ft.	BDL
9073M		1-3/8" x 4"	Ultralite MDF	16' 2



M&M#	WM#	Casing	Ln.Ft.	BDL
9038M		1 1/16" x 4-1/2"	Ultralite MDF	16' 2



M&M#	WM#	Casing	Ln.Ft.	BDL
9043M		1-1/16" x 3-1/2"	Ultralite MDF	16' 4

M&M#	WM#	Casing	Ln.Ft.	BDL
9063M		1" x 4-1/4"	Ultralite MDF	16' 2

Casings

Casings define the overall character of a room and are often the most visible part of the trim. Casings are used primarily to cover the gap between drywall and the door or window frame. Casings are generally thicker than the base mouldings.

ALL SIZES NOMINAL

M&M#	WM#	Fluted Pilaster Stock	Ln.Ft.	BDL
4412P		11/16" x 4-1/2" Primed FJ	16'	

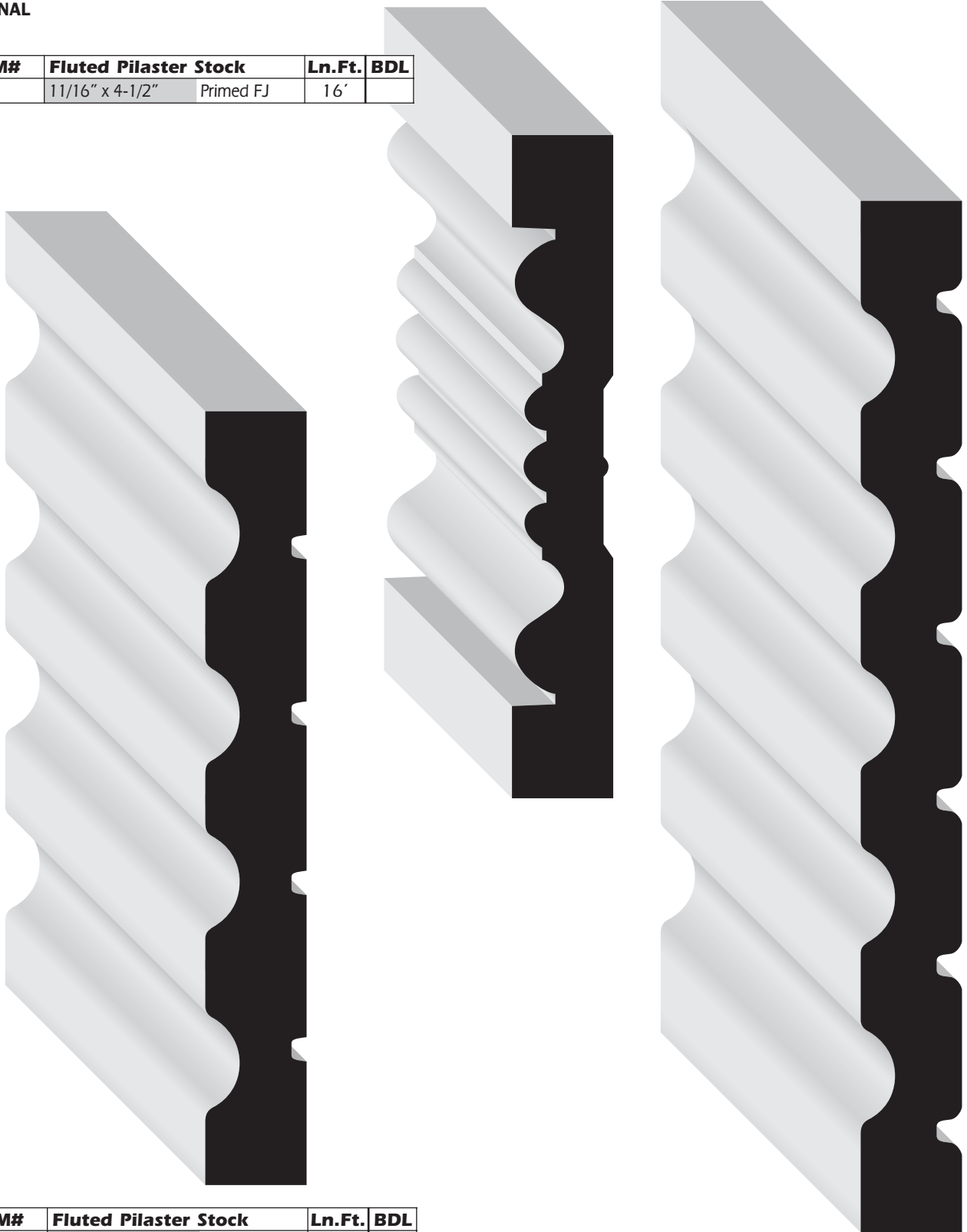

M&M#	WM#	Fluted Pilaster Stock	Ln.Ft.	BDL
FP16P		11/16" x 5-1/4" Primed FJ	16'	6

M&M#	WM#	Fluted Pilaster Stock	Ln.Ft.	BDL
FP18P		11/16" x 7" Primed FJ	16'	4

Casings

Casings define the overall character of a room and are often the most visible part of the trim. Casings are used primarily to cover the gap between drywall and the door or window frame. Casings are generally thicker than the base mouldings.

ALL SIZES NOMINAL

M&M#	WM#	Ranch	Ln.Ft.	BDL
316	316	11/16" x 2-1/4" Solid Pine	RL	12

M&M#	WM#	Ranch	Ln.Ft.	BDL
327	327	11/16" x 2-1/4" Solid Pine	RL	12
327FJ	327	11/16" x 2-1/4" Finger Joint	14'	12
327P	327	11/16" x 2-1/4" Primed FJ	14'	12
327XO	327	5/8" x 2-1/4" Oak	RL	12

All above 327 species available in 7' legs

M&M#	WM#	Ranch	Ln.Ft.	BDL
330	330	11/16" x 2-1/4" Solid Pine	RL	12

M&M#	WM#	Waterfall	Ln.Ft.	BDL
387	387	5/8" x 2-1/2" Solid Pine	RL	12

M&M#	WM#	Casing	Ln.Ft.	BDL
9037M		5/8" x 3-1/4" Ultralite MDF	16'	6

M&M#	WM#	Reeded	Ln.Ft.	BDL
908M	201	15mm x 3-1/4" Ultralite MDF	16'	7

M&M#	WM#	Fluted/Reeded	Ln.Ft.	BDL
37	37	11/16" x 3-1/4" Solid Pine	RL	10
37FJ	37	11/16" x 3-1/4" Finger Joint	16'	10
37P	37	11/16" x 3-1/4" Primed FJ	16'	10

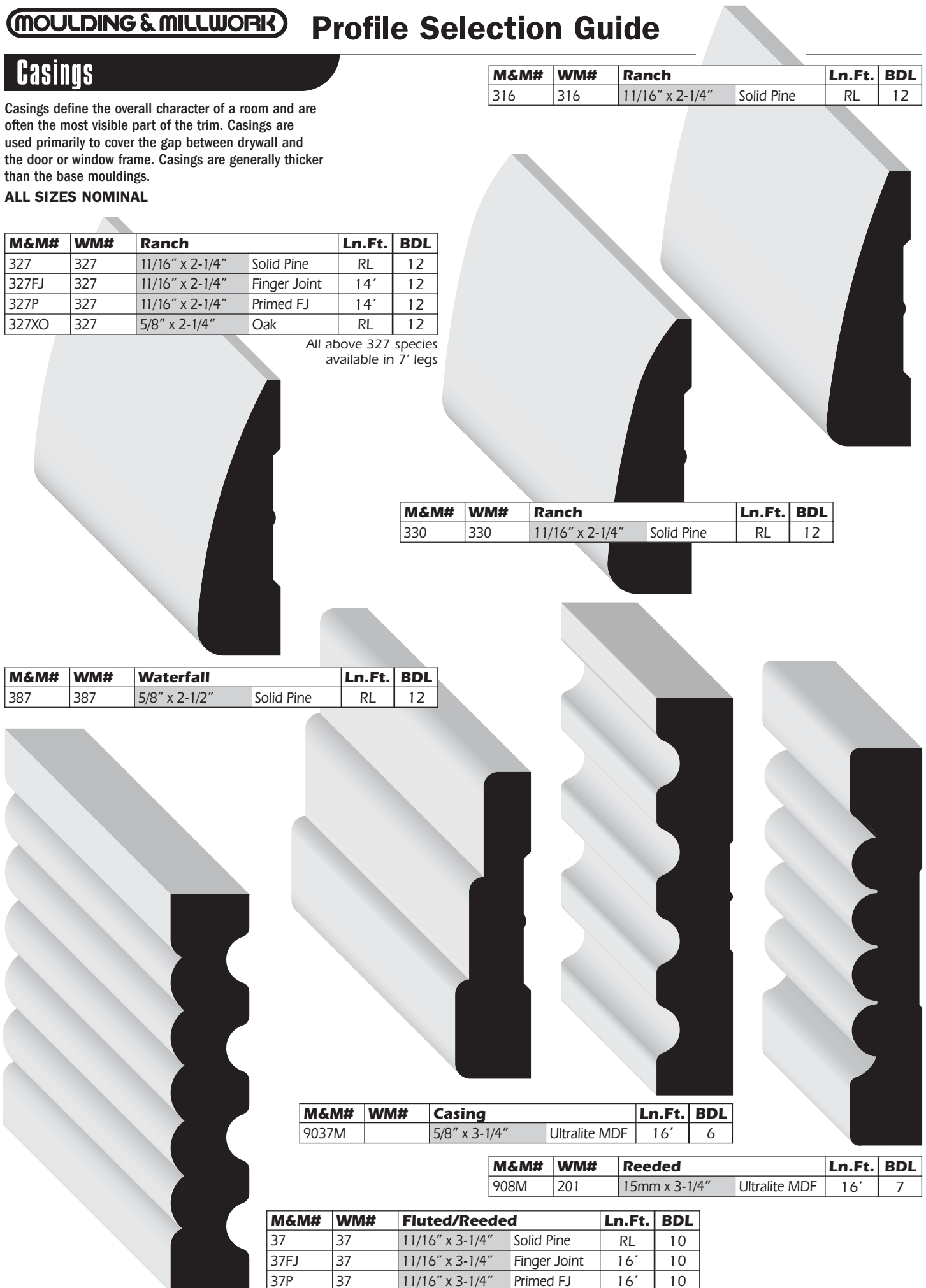

Plinths

ALL SIZES NOMINAL

M&M#	WM#	Solid Plinth	Ln.Ft.	BDL
9	735	3/4" x 2-5/8" Solid Pine	RL	8



M&M#	WM#	Solid Plinth	Ln.Ft.	BDL
11		1-3/16" x 3-7/8" Solid Pine	RL	6



M&M#	WM#	Solid Plinth	Ln.Ft.	BDL
10		3/4" x 3-1/2" Solid Pine	RL	8



M&M#	WM#	Solid Plinth	Ln.Ft.	BDL
ACP		1-1/4" x 3-3/4" Solid Pine	RL	6



Baseboards

Baseboards run along the wall at the floor. Baseboards should be chosen to work in harmony with your casings to finish and tie the room together. Baseboards are usually thinner than the casing.

ALL SIZES NOMINAL

M&M#	WM#	Heritage	Ln.Ft.	BDL
8263M	8263	15mm x 6-1/2" Ultralite MDF	16'	3

M&M#	WM#	Colonial	Ln.Ft.	BDL
412M		15mm x 4-1/4" Ultralite MDF	16'	6

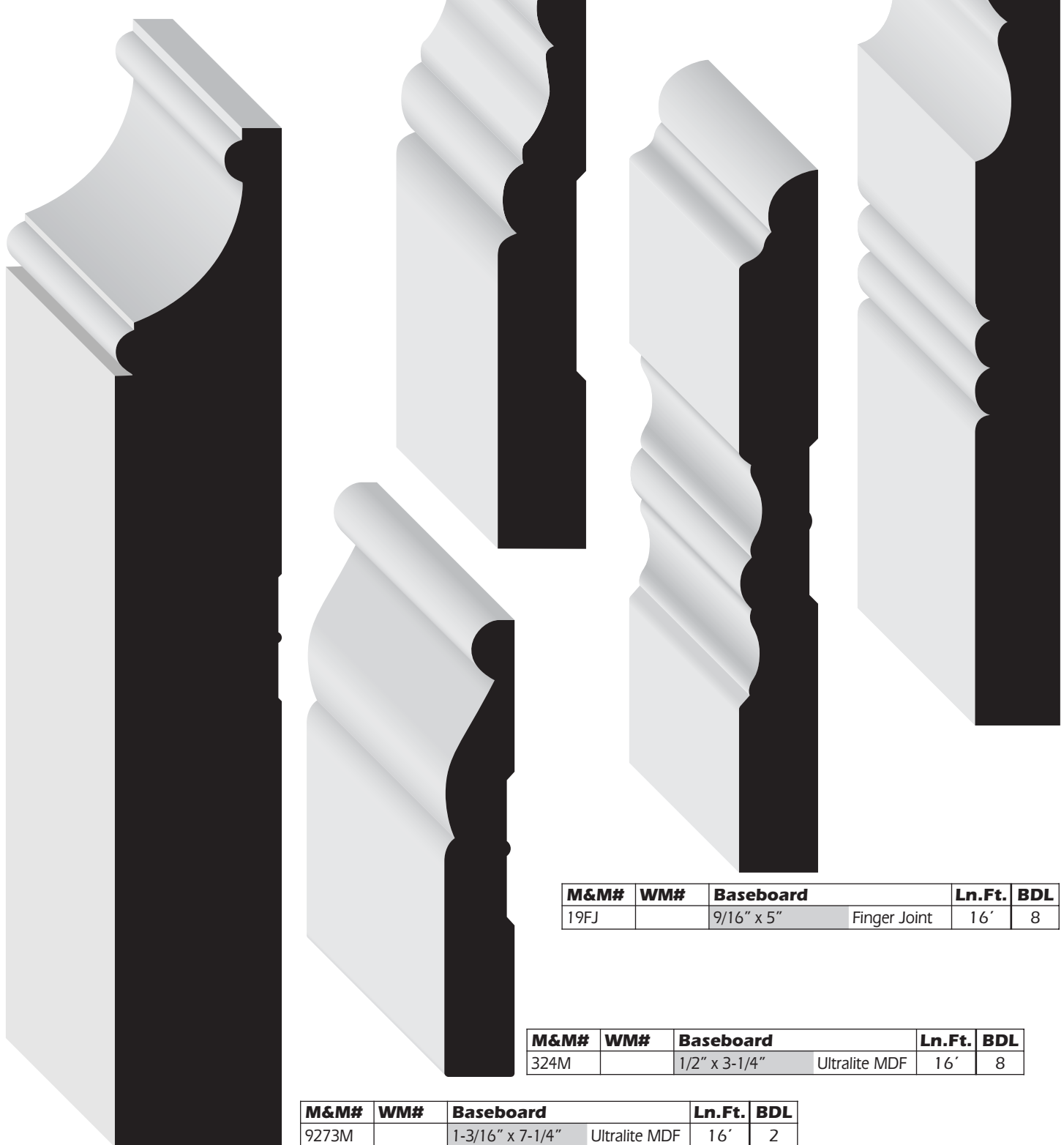

M&M#	WM#	Baseboard	Ln.Ft.	BDL
19FJ		9/16" x 5" Finger Joint	16'	8

M&M#	WM#	Baseboard	Ln.Ft.	BDL
324M		1/2" x 3-1/4" Ultralite MDF	16'	8

M&M#	WM#	Baseboard	Ln.Ft.	BDL
9273M		1-3/16" x 7-1/4" Ultralite MDF	16'	2

Baseboards

Baseboards run along the wall at the floor. Baseboards should be chosen to work in harmony with your casings to finish and tie the room together. Baseboards are usually thinner than the casing.

ALL SIZES NOMINAL

M&M#	WM#	Colonial/F.E.	Ln.Ft.	BDL
618	618	9/16" x 5-1/4" Solid Pine	RL	8
618FJ	618	9/16" x 5-1/4" Finger Joint	16'	8
618P	618	9/16" x 5-1/4" Primed FJ	16'	8
618MR	618	9/16" x 5-1/4" Ultralite MDF	16'	6

M&M#	WM#	Colonial/F.E.	Ln.Ft.	BDL
620	620	9/16" x 4-1/4" Solid Pine	RL	8
620FJ	620	9/16" x 4-1/4" Finger Joint	16'	8
620P	620	9/16" x 4-1/4" Primed FJ	16'	8
620O	620	1/2" x 4-1/4" Oak	RL	8
620M	620	12mm x 4-1/4" Ultralite MDF	16'	10

M&M#	WM#	Colonial/F.E.	Ln.Ft.	BDL
622	622	9/16" x 3-1/2" Solid Pine	RL	10
622P	622	9/16" x 3-1/2" Primed FJ	RL	10
622O	622	1/2" x 3-1/2" Solid Oak	RL	10

M&M#	WM#	Colonial/F.E.	Ln.Ft.	BDL
623	623	9/16" x 3-1/4" Solid Pine	RL	10
623FJ	623	9/16" x 3-1/4" Finger Joint	16'	10
623P	623	9/16" x 3-1/4" Primed FJ	16'	10
623M	623	12mm x 3-1/4" Ultralite MDF	16'	10

M&M#	WM#	Colonial/F.E.	Ln.Ft.	BDL
624FJS	624	7/16" x 3" Finger Joint	16'	10
624O	624	1/2" x 3" Oak	RL	8
624M	624	1/2" x 3" Ultralite MDF	16'	8
624	624	9/16" x 3" Solid Pine	RL	10
624FJ	624	9/16" x 3" Finger Joint	16'	10
624P	624	9/16" x 3" Primed FJ	16'	10

M&M#	WM#	Colonial/F.E.	Ln.Ft.	BDL
626P	626	7/16" x 2-1/4" Primed FJ	16'	20

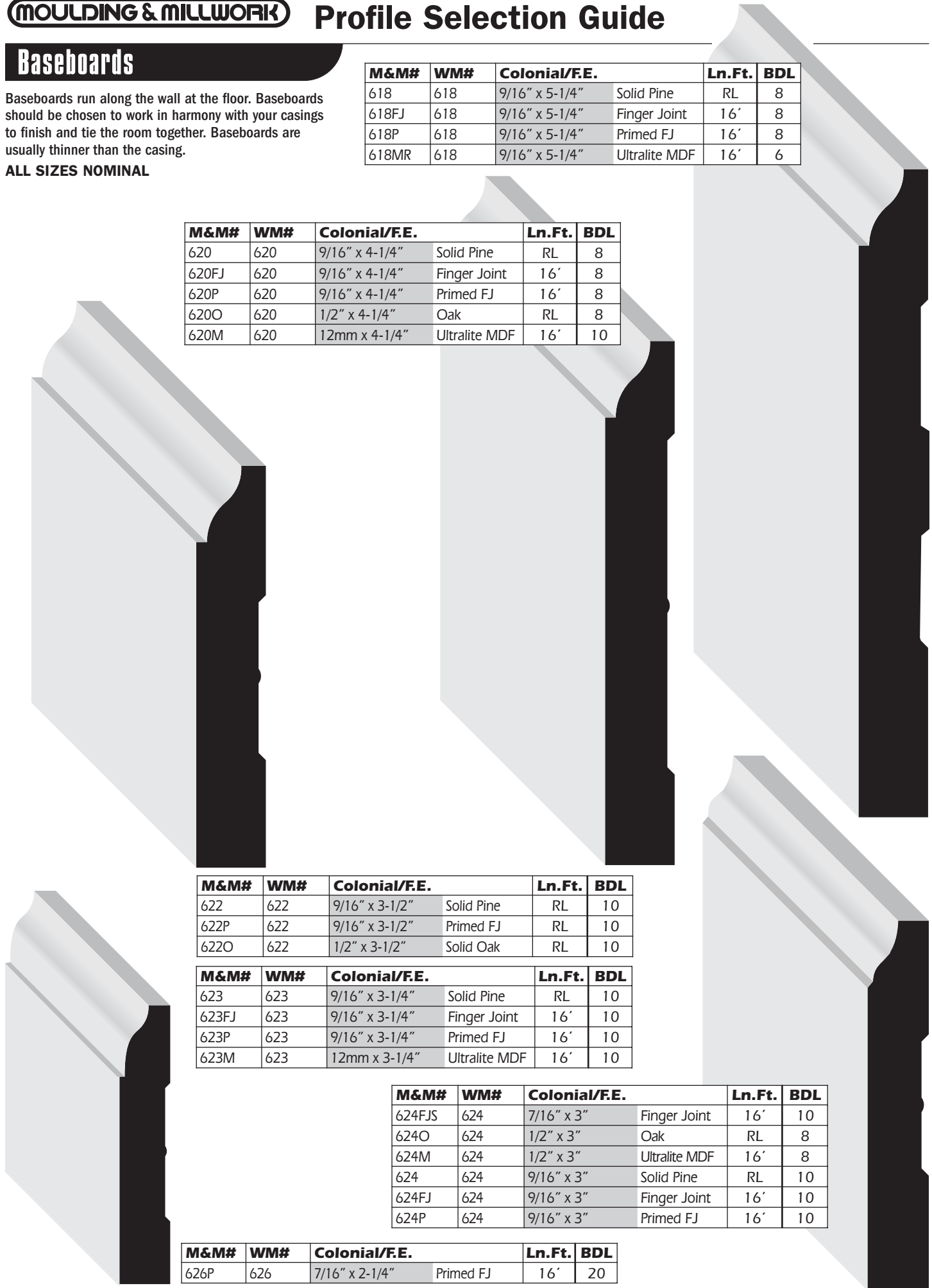

Baseboards

Baseboards run along the wall at the floor. Baseboards should be chosen to work in harmony with your casings to finish and tie the room together. Baseboards are usually thinner than the casing.

ALL SIZES NOMINAL

M&M#	WM#	Colonial/Beaded		Ln.Ft.	BDL
753	753	9/16" x 3-1/4"	Solid Pine	RL	10
753FJ	753	9/16" x 3-1/4"	Finger Joint	16'	10
753P	753	9/16" x 3-1/4"	Primed FJ	16'	10
753M	753	1/2" x 3-1/4"	Ultralite MDF	16'	6

M&M#	WM#	Baseboard		Ln.Ft.	BDL
750WM		11/16" x 5-1/2"	Ultralite MDF	16'	2

M&M#	WM#	Ranch		Ln.Ft.	BDL
714O	714	1/2" x 3"	Oak	RL	8
714P	714	1/2" x 3"	Primed FJ	16'	10
714	714	9/16" x 3"	Solid Pine	RL	10

M&M#	WM#	Colonial/Beaded		Ln.Ft.	BDL
750	750	9/16" x 4-1/4"	Solid Pine	RL	8
750FJ	750	9/16" x 4-1/4"	Finger Joint	16'	8
750P	750	9/16" x 4-1/4"	Primed FJ	16'	8
750W	750	9/16" x 5-1/4"	Solid Pine	RL	6
750WFJ	750	9/16" x 5-1/4"	Finger Joint	16'	8
750WP	750	9/16" x 5-1/4"	Primed FJ	16'	8
750M	750	1/2" x 4-1/4"	Ultralite MDF	16'	6

M&M#	WM#	Ranch		Ln.Ft.	BDL
713	713	9/16" x 3-1/4"	Solid Pine	RL	10
713FJ	713	9/16" x 3-1/4"	Finger Joint	16'	10
713P	713	9/16" x 3-1/4"	Primed FJ	16'	10



Baseboards

Baseboards run along the wall at the floor. Baseboards should be chosen to work in harmony with your casings to finish and tie the room together. Baseboards are usually thinner than the casing.

ALL SIZES NOMINAL

M&M#	WM#	Combo/Speed	Ln.Ft.	BDL
163EM	163E	15mm x 5-1/4" Ultralite MDF	16'	6

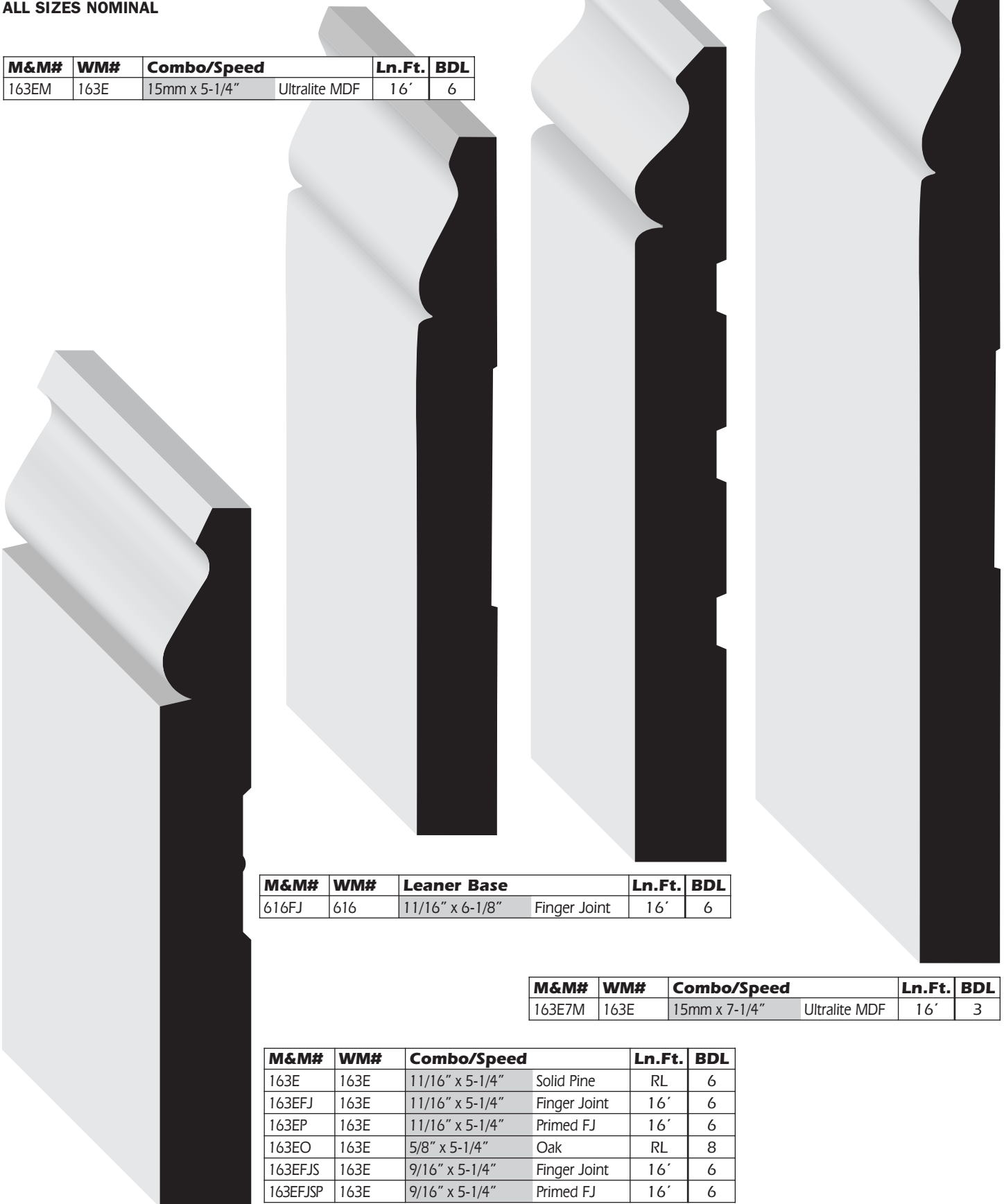

M&M#	WM#	Leaner Base	Ln.Ft.	BDL
616FJ	616	11/16" x 6-1/8" Finger Joint	16'	6

M&M#	WM#	Combo/Speed	Ln.Ft.	BDL
163E7M	163E	15mm x 7-1/4" Ultralite MDF	16'	3

M&M#	WM#	Combo/Speed	Ln.Ft.	BDL
163E	163E	11/16" x 5-1/4" Solid Pine	RL	6
163EFJ	163E	11/16" x 5-1/4" Finger Joint	16'	6
163EP	163E	11/16" x 5-1/4" Primed FJ	16'	6
163EO	163E	5/8" x 5-1/4" Oak	RL	8
163EFJS	163E	9/16" x 5-1/4" Finger Joint	16'	6
163EFJSP	163E	9/16" x 5-1/4" Primed FJ	16'	6

Baseboards

Baseboards run along the wall at the floor. Baseboards should be chosen to work in harmony with your casings to finish and tie the room together. Baseboards are usually thinner than the casing.

ALL SIZES NOMINAL

M&M#	WM#	Leaner Base	Ln.Ft.	BDL
791P	791	11/16" x 2-1/4" Primed FJ	16'	12

M&M#	WM#	Colonial/O.G.	Ln.Ft.	BDL
663	663	9/16" x 3-1/4" Solid Pine	RL	10
663FJ	663	9/16" x 3-1/4" Finger Joint	16'	10
663P	663	9/16" x 3-1/4" Primed FJ	16'	10
663M	663	12mm x 3-1/4" Ultralite MDF	16'	10

M&M#	WM#	Baseboard	Ln.Ft.	BDL
662M	662	1/2" x 3-1/2" Ultralite MDF	16'	10
662O	662	1/2" x 3-1/2" Solid Oak	RL	10
662	662	9/16" x 3-1/2" Solid Pine	RL	10
662P	662	9/16" x 3-1/2" Primed FJ	16'	10

M&M#	WM#	Baseboard	Ln.Ft.	BDL
9283M	9283	1-3/16" x 7-1/4" Ultralite MDF	16'	2

M&M#	WM#	Baseboard	Ln.Ft.	BDL
8243M	8243	1/2" x 4-1/4" Ultralite MDF	16'	4

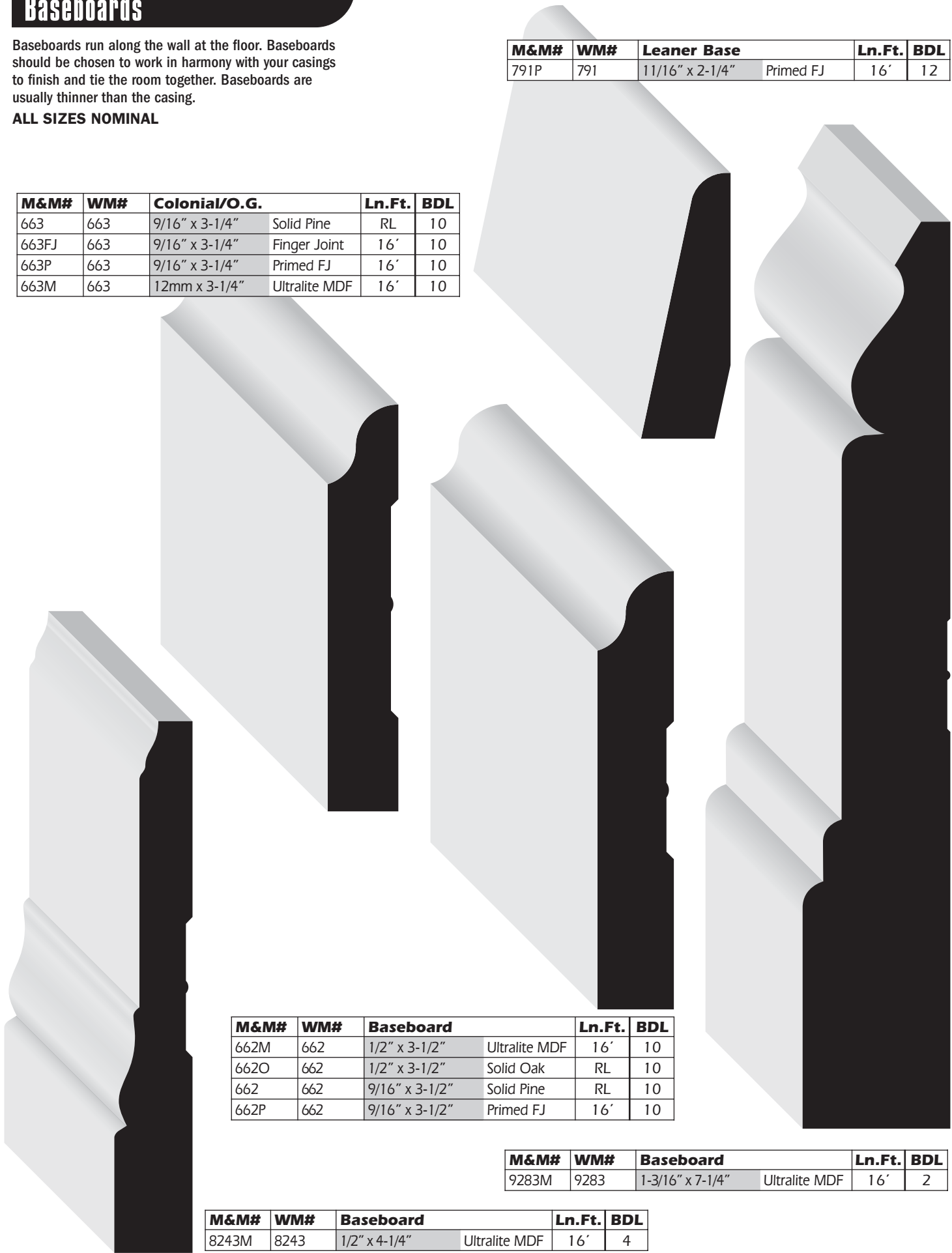

Baseboards

Baseboards run along the wall at the floor. Baseboards should be chosen to work in harmony with your casings to finish and tie the room together. Baseboards are usually thinner than the casing.

ALL SIZES NOMINAL

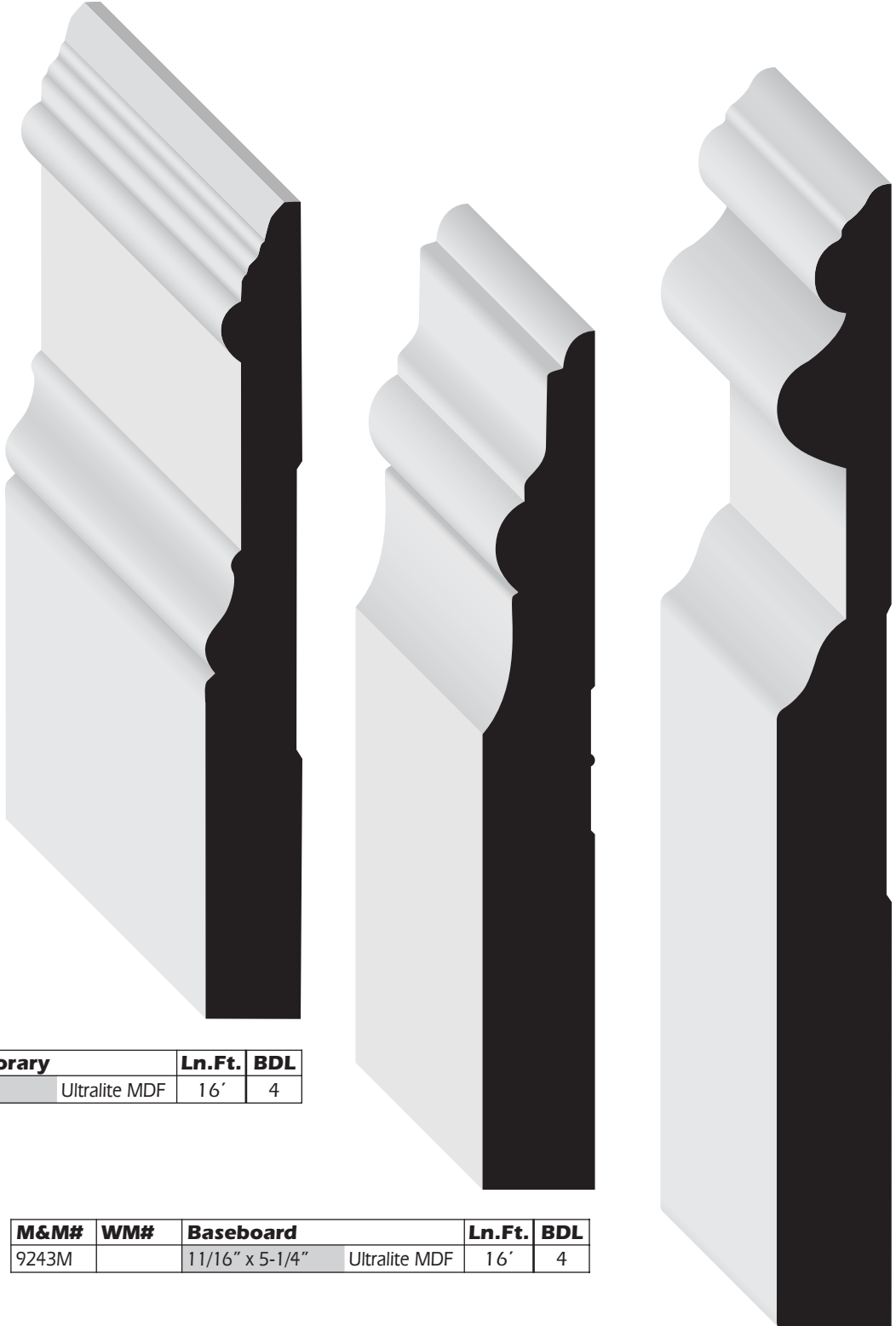

M&M#	WM#	Contemporary	Ln.Ft.	BDL
545M		15mm x 5" Ultralite MDF	16'	4

M&M#	WM#	Baseboard	Ln.Ft.	BDL
9243M		1 1/16" x 5-1/4" Ultralite MDF	16'	4

M&M#	WM#	Baseboard	Ln.Ft.	BDL
9263M		3/4" x 7" Ultralite MDF	16'	2

Baseboards

Baseboards run along the wall at the floor. Baseboards should be chosen to work in harmony with your casings to finish and tie the room together. Baseboards are usually thinner than the casing.

ALL SIZES NOMINAL

M&M#	WM#	Colonial/F.E.	Ln.Ft.	BDL
665FJ	665	9/16" x 4" Raw FJ	16'	8



M&M#	WM#	Baseboard	Ln.Ft.	BDL
9233M		11/16" x 4-5/8" Ultralite MDF	16'	4

M&M#	WM#	Baseboard	Ln.Ft.	BDL
9253M		11/16" x 6-3/4" Ultralite MDF	16'	2

M&M#	WM#	Baseboard	Ln.Ft.	BDL
207M		5/8" x 7-3/16" Ultralite MDF	16'	4

Crowns



M&M#	WM#	Crown		Ln.Ft.	BDL
45	45	11/16" x 5-1/4"	Solid Pine	RL	8
45FJ	45	11/16" x 5-1/4"	Finger Joint	16'	8
45P	45	11/16" x 5-1/4"	Primed FJ	16'	8
45M	45	15mm x 5-1/4"	Ultralite MDF	16'	4
PVC45	45	11/16" x 5-1/4"	PVC	16'	6



M&M#	WM#	Crown		Ln.Ft.	BDL
785M	L303	11/16" x 4-5/8"	Ultralite MDF	16'	4

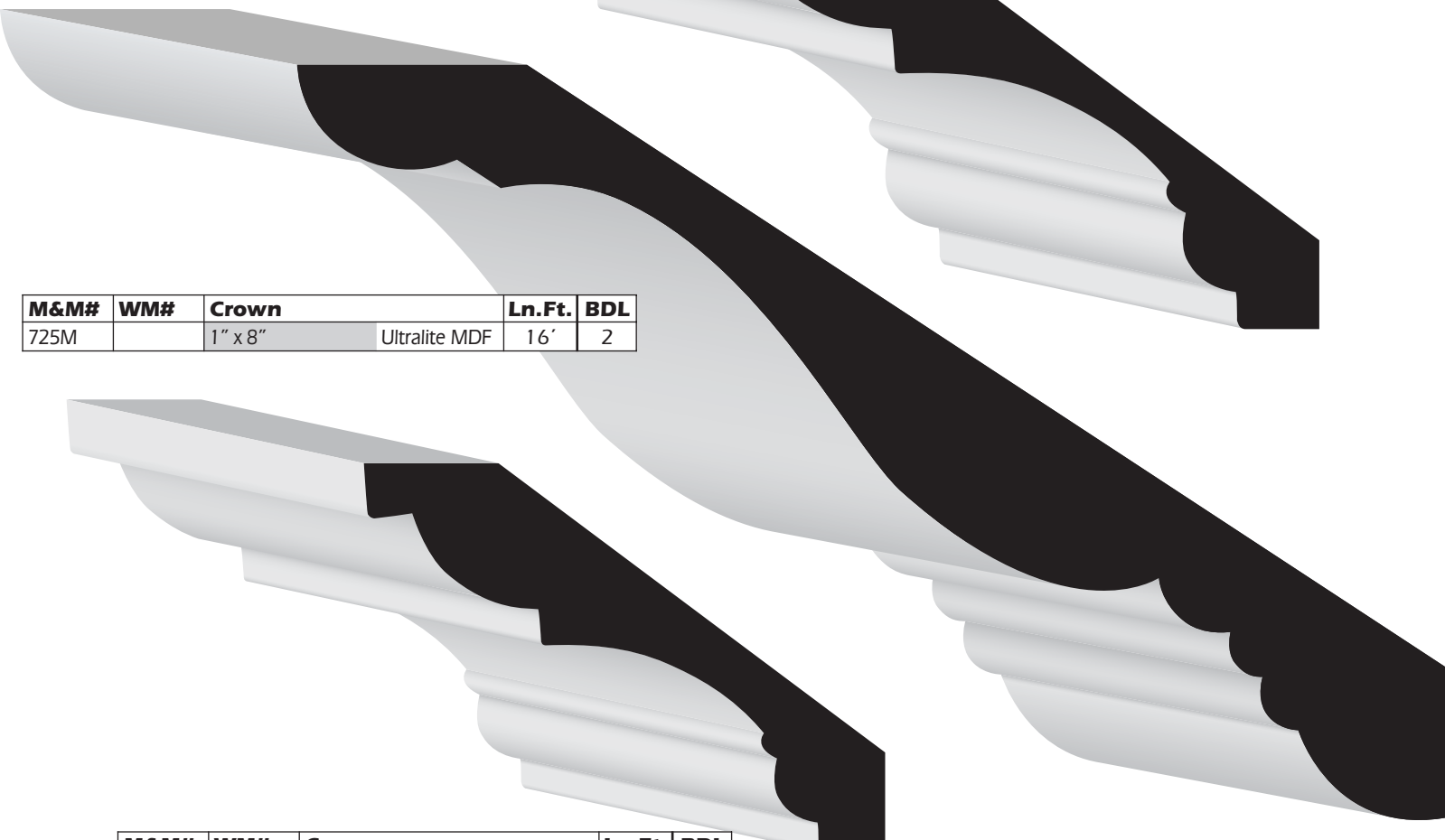

M&M#	WM#	Crown		Ln.Ft.	BDL
725M		1" x 8"	Ultralite MDF	16'	2



M&M#	WM#	Crown		Ln.Ft.	BDL
784M		11/16" x 3-11/16"	Ultralite MDF	16'	6

Crowns

Crowns run along the wall at the ceiling. Crowns come in a wide range of sizes and patterns. Crowns soften the transition from wall to ceiling while adding a distinctive look and charm to most rooms.

ALL SIZES NOMINAL

M&M#	WM#	Crown		Ln.Ft.	BDL
49	L49	9/16" x 3-5/8"	Ultralite MDF	16'	8
49FJ	L49	9/16" x 3-5/8"	Finger Joint	16'	8
49P	L49	9/16" x 3-5/8"	Primed FJ	16'	8
49O	L49	5/8" x 3-5/8"	Oak	RL	8
PVC49S	LPVC49	9/16" x 3-5/8"	PVC	16'	10
49M	49	15mm x 3-5/8"	Ultralite MDF	16'	8

M&M#	WM#	Crown		Ln.Ft.	BDL
WP712P		3/4" x 4-1/2"	Primed FJ	16'	6

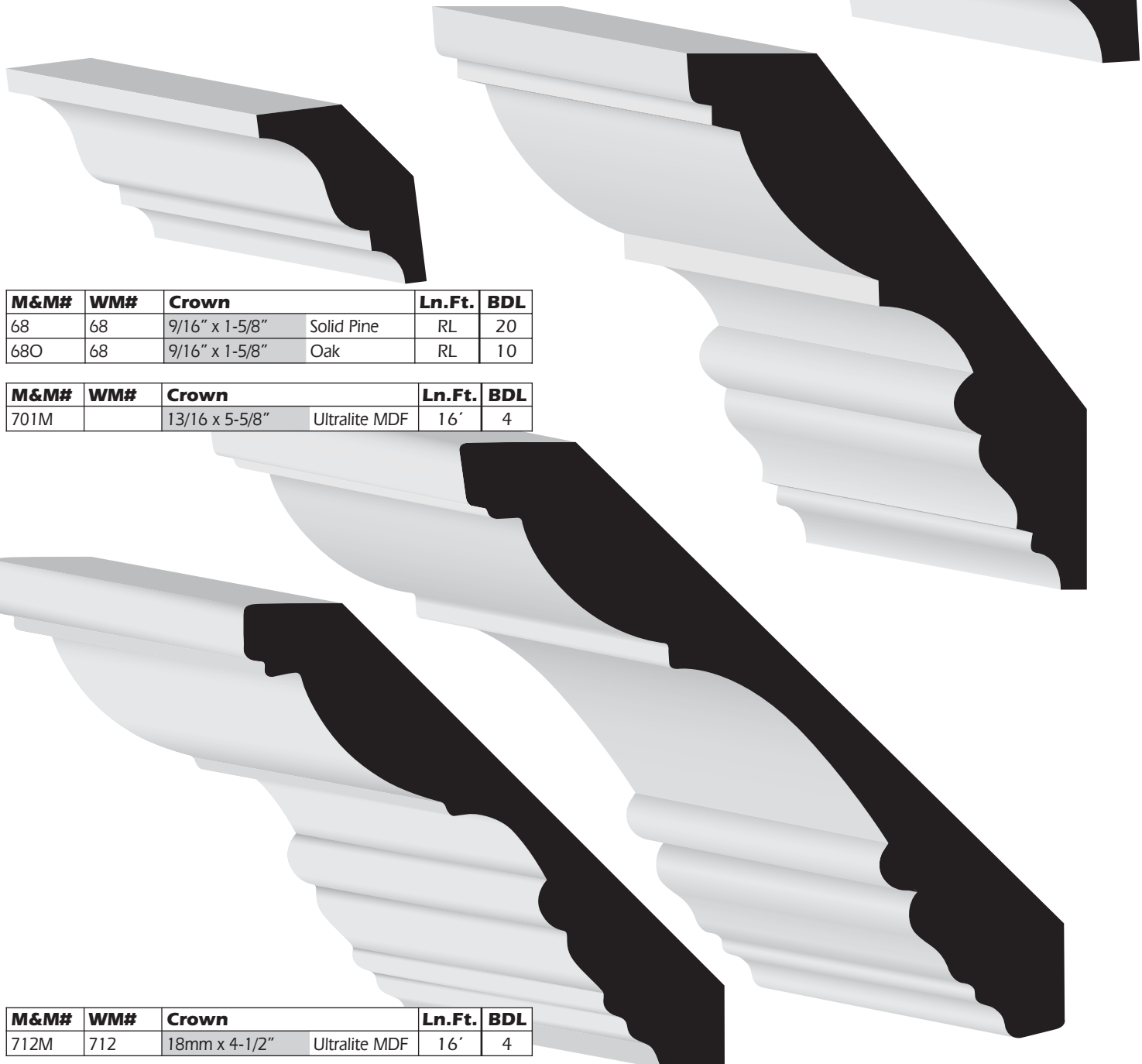

M&M#	WM#	Crown		Ln.Ft.	BDL
68	68	9/16" x 1-5/8"	Solid Pine	RL	20
68O	68	9/16" x 1-5/8"	Oak	RL	10

M&M#	WM#	Crown		Ln.Ft.	BDL
701M		13/16 x 5-5/8"	Ultralite MDF	16'	4

M&M#	WM#	Crown		Ln.Ft.	BDL
712M	712	18mm x 4-1/2"	Ultralite MDF	16'	4

Crowns

Crowns run along the wall at the ceiling. Crowns come in a wide range of sizes and patterns. Crowns soften the transition from wall to ceiling while adding a distinctive look and charm to most rooms.

ALL SIZES NOMINAL

M&M#	WM#	Crown	Ln.Ft.	BDL
44	44	11/16" x 4-1/4" Solid Pine	RL	6
44P	44	11/16" x 4-1/4" Primed FJ	16'	6
44M	44	15mm x 4-1/4" Ultralite MDF	16'	6

M&M#	WM#	Crown	Ln.Ft.	BDL
47	L47	9/16" x 4-5/8" Solid Pine	RL	6
47FJ	L47	9/16" x 4-5/8" Finger Joint	16'	8
47P	L47	9/16" x 4-5/8" Primed FJ	16'	8
47O	L47	5/8" x 4-5/8" Oak	RL	6
PVC47	PVC47	11/16" x 4-5/8" PVC	16'	5
47M	47	15mm x 4-5/8" Ultralite MDF	16'	8

M&M#	WM#	Crown	Ln.Ft.	BDL
43M		25mm x 6-15/16" Ultralite MDF	16'	2

M&M#	WM#	Crown	Ln.Ft.	BDL
53	53	9/16" x 2-5/8" Solid Pine	RL	12
53FJ	53	9/16" x 2-5/8" Finger Joint	16'	12
53P	53	9/16" x 2-5/8" Primed FJ	16'	12
53O	53	5/8" x 2-1/2" Oak	RL	12

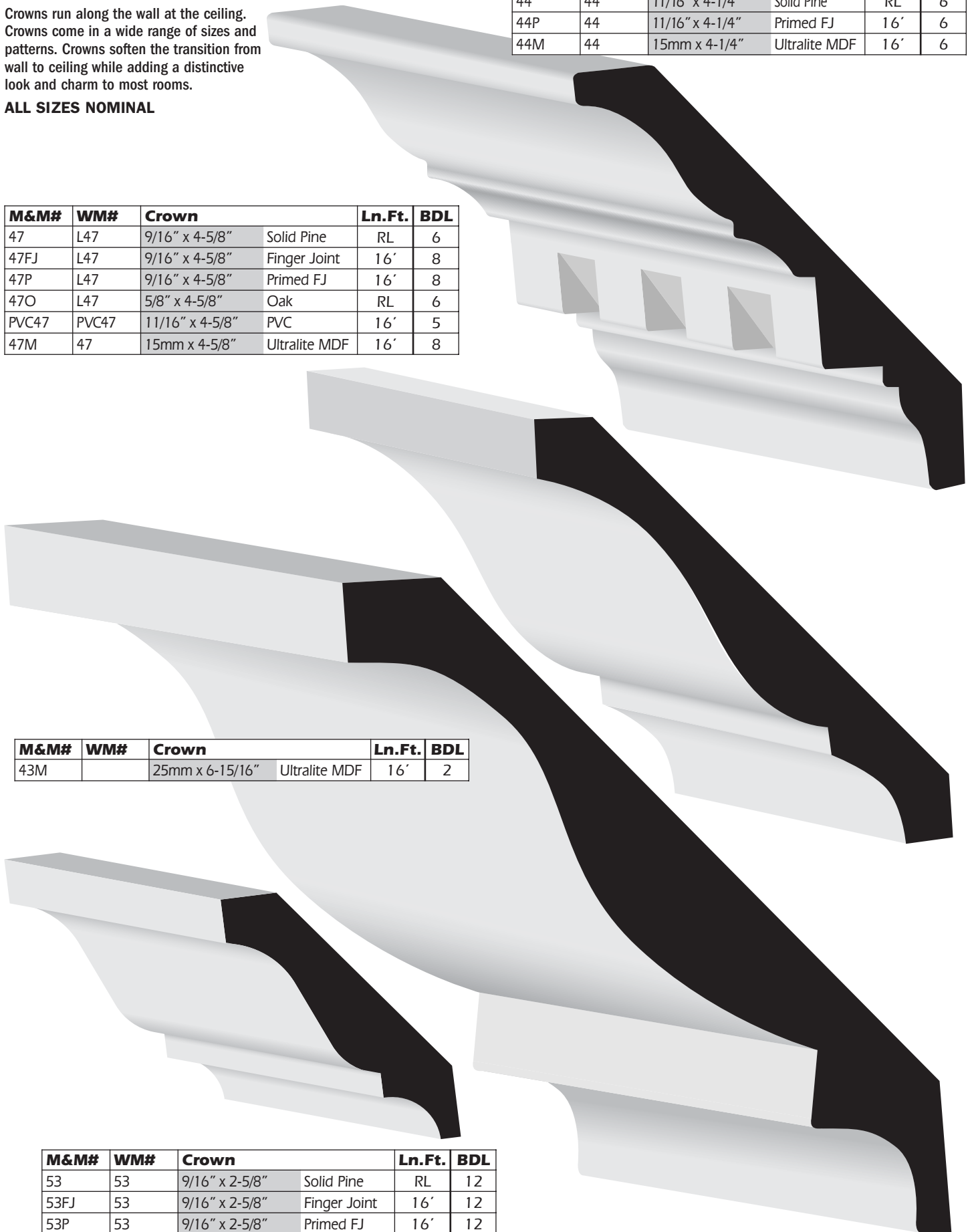

Crowns

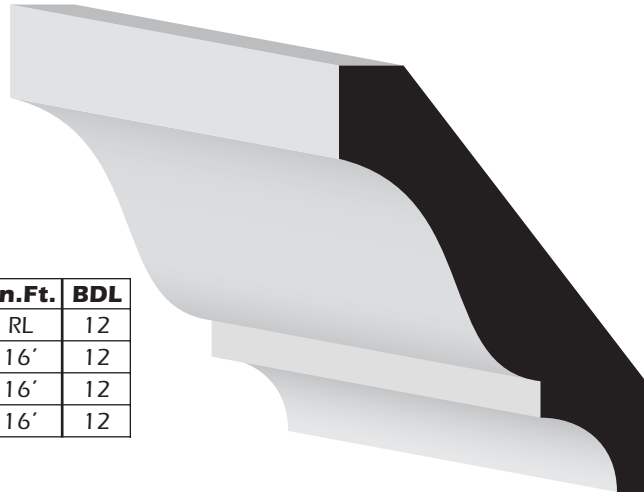

M&M#	WM#	Crown	Ln.Ft.	BDL
52	52	9/16" x 2-3/4" Solid Pine	RL	12
52FJ	52	9/16" x 2-3/4" Finger Joint	16'	12
52P	52	9/16" x 2-3/4" Primed FJ	16'	12
52M	52	15mm x 2-3/4" Ultralite	16'	12



M&M#	WM#	Crown	Ln.Ft.	BDL
54	54	9/16" x 2-1/4" Solid Pine	RL	12

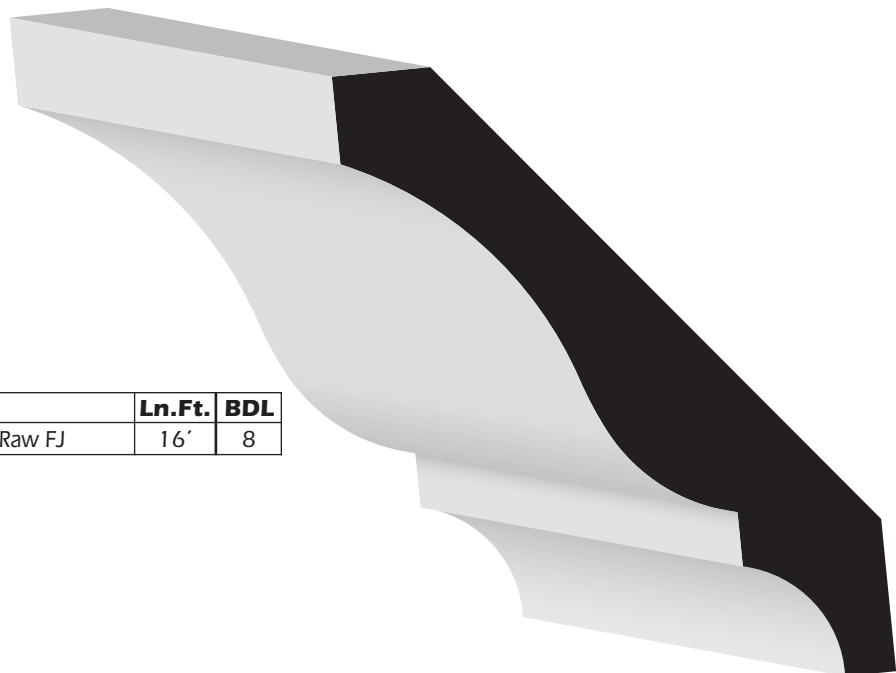

M&M#	WM#	Crown	Ln.Ft.	BDL
48FJ	48	1 1/16" x 4-1/4" Raw FJ	16'	8

Crowns

M&M#	WM#	Crown		Ln.Ft.	BDL
41M		30mm x 6-5/16"	Ultralite MDF	16'	2

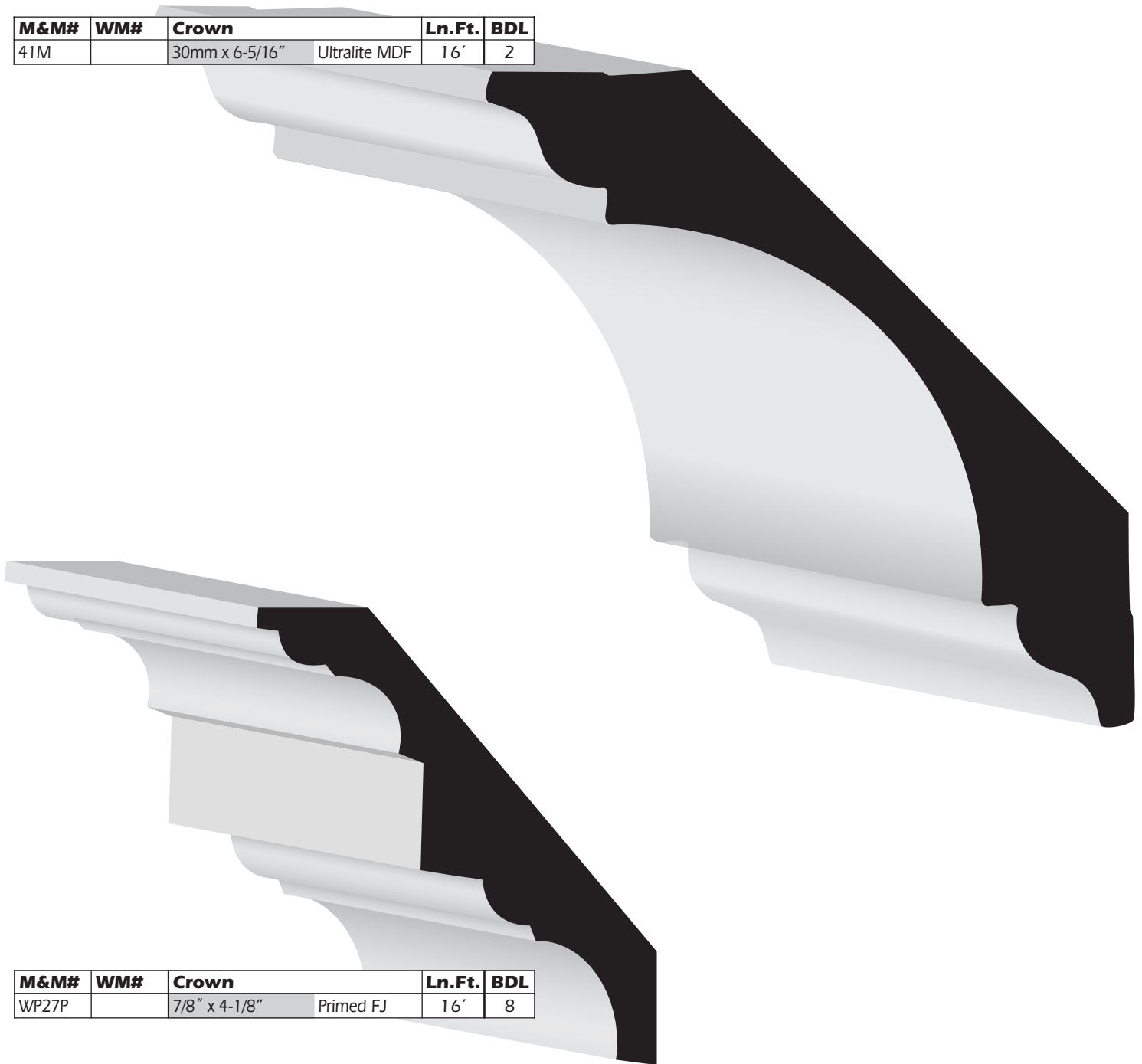

M&M#	WM#	Crown		Ln.Ft.	BDL
WP27P		7/8" x 4-1/8"	Primed FJ	16'	8

Crowns



M&M#	WM#	Crown	Ln.Ft.	BDL
443M		1-1/16 x 3-9/16" Ultralite MDF	16'	4

M&M#	WM#	Crown	Ln.Ft.	BDL
270M		11/16 x 6-3/4" Ultralite MDF	16'	4

M&M#	WM#	Crown	Ln.Ft.	BDL
271M		11/16 x 5-1/4" Ultralite MDF	16'	4

M&M#	WM#	Crown	Ln.Ft.	BDL
716M		1-3/16 x 5" Ultralite MDF	16'	2

Coves

This profile has a wide range of uses. It is most commonly used to soften the transition on inside corners.

ALL SIZES NOMINAL

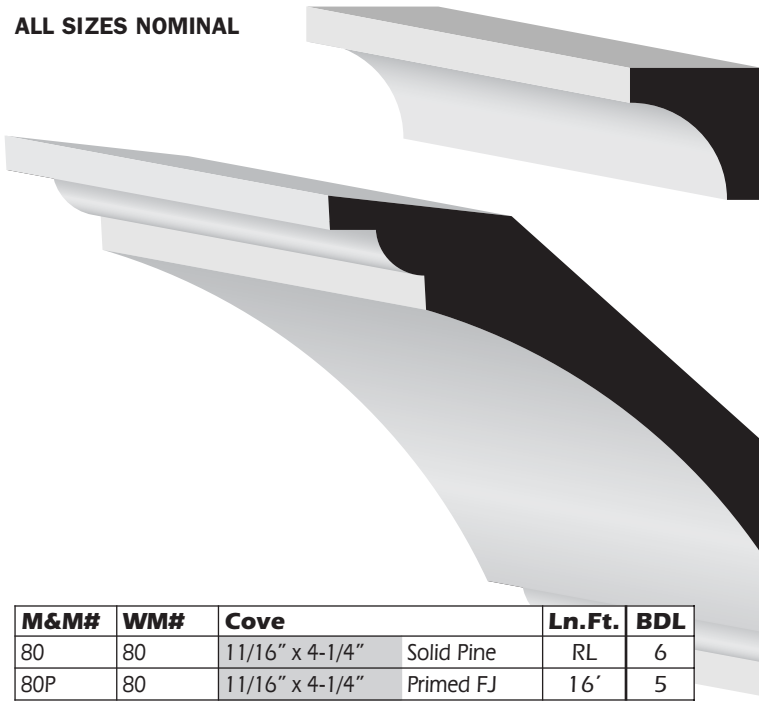

M&M#	WM#	Cove	Ln.Ft.	BDL
93	93	3/4" x 3/4" Solid Pine	RL	40
93O	93	3/4" x 3/4" Oak	RL	20

M&M#	WM#	Cove	Ln.Ft.	BDL
100	100	1 1/16" x 1 1/16" Solid Pine	RL	40
100-8	100	1 1/16" x 1 1/16" Solid Pine	8'	40
100FJ	100	1 1/16" x 1 1/16" Finger Joint	16'	
100P	100	1 1/16" x 1 1/16" Primed FJ	16'	40
100O	100	1 1/16" x 1 1/16" Oak	RL	20
100OF08	100	1 1/16" x 1 1/16" Oak	8'	20
101-8	101	1/2" x 1/2" Solid Pine	8'	50
101	101	1/2" x 1/2" Solid Pine	RL	50

M&M#	WM#	Cove	Ln.Ft.	BDL
84	84	9/16" x 2-1/4" Solid Pine	RL	12
85	85	9/16" x 1-3/4" Solid Pine	RL	20
86	86	9/16" x 1-5/8" Solid Pine	RL	20

M&M#	WM#	Cove	Ln.Ft.	BDL
80	80	1 1/16" x 4-1/4" Solid Pine	RL	6
80P	80	1 1/16" x 4-1/4" Primed FJ	16'	5

Bed Mouldings

ALL SIZES NOMINAL



M&M#	WM#	Bed Moulding	Ln.Ft.	BDL
WP28P	28	1 1/16" x 3-9/16" Primed FJ	16'	8

M&M#	WM#	Bed Moulding	Ln.Ft.	BDL
70	70	9/16" x 2-3/4" Solid Pine	RL	12

M&M#	WM#	Bed Moulding	Ln.Ft.	BDL
74	74	9/16" x 1-3/4" Solid Pine	RL	20
74FJ	74	9/16" x 1-3/4" Finger Joint	16'	20
74P	74	9/16" x 1-3/4" Primed FJ	16'	20

M&M#	WM#	Bed Moulding	Ln.Ft.	BDL
75O	75	1/2" x 1-5/8" Oak	RL	20
75	75	9/16" x 1-5/8" Solid Pine	RL	20
75FJ	75	9/16" x 1-5/8" Finger Joint	16'	20
75P	75	9/16" x 1-5/8" Primed FJ	16'	20
PVC75-16	75	9/16" x 1-5/8" PVC	16'	28

Chair Rails & Backers

Chair rails have a decorative and practical function. Applied to a wall anywhere from 24 to 48 inches from the floor, they are a beautiful accent to the room, while also protecting the wall from scuffs and dents from the backs of chairs.

ALL SIZES NOMINAL

M&M#	WM#			Ln.Ft.	BDL
297	297	1 1/16" x 3"	Solid Pine	RL	10
297FJ	297	1 1/16" x 3"	Finger Joint	16'	10
297P	297	1 1/16" x 3"	Primed FJ	16'	10
297M	297	15mm x 3"	Ultralite MDF	16'	6

M&M#	WM#	Rabbeted		Ln.Ft.	BDL
77	77	9/16" x 2-1/4"	Solid Pine	RL	12

M&M#	WM#	Colonial		Ln.Ft.	BDL
390	390	1 1/16" x 2-5/8"	Solid Pine	RL	12
390FJ	390	1 1/16" x 2-5/8"	Finger Joint	16'	12
390P	390	1 1/16" x 2-5/8"	Primed FJ	16'	12
390O	390	5/8" x 2-5/8"	Oak	RL	12
390M	390	5/8" x 2-5/8"	Ultralite MDF	16'	8

M&M#	WM#	Chair Rail		Ln.Ft.	BDL
397		9/16" x 2-1/4"	Solid Pine	RL	6
397M		25mm x 3-1/2"	Ultralite	16'	6
397FJ		1" x 3-1/2"	Fingerjoint	16'	6
956	956	3/8" x 2"	Solid Pine	RL	20
956FJ	956	3/8" x 2"	Finger Joint	16'	20
956W	956	3/8" x 3-1/4"	Solid Pine	RL	10
956WP	956	3/8" x 3-1/4"	Primed FJ	16'	10
956FJWV	956	1/4" x 3-3/4"		16'	12
956WW	956	3/8" x 4-1/4"	Solid Pine	RL	10
956WWFJ	956	7/16" x 4-1/4"	Finger Joint	16'	10
956WWP	956	7/16" x 4-1/4"	Primed FJ	16'	10
956WWM	956	12mm x 4-1/4"	Ultralite MDF	16'	6
L956WM	956	12mm x 5-1/4"	Ultralite MDF	16'	

M&M#	WM#	Chair Rail Backer		Ln.Ft.	BDL
398	398	1/2" x 5-1/4"	Solid Pine	RL	8
398FJ	398	1/2" x 5-1/4"	Finger Joint	16'	8

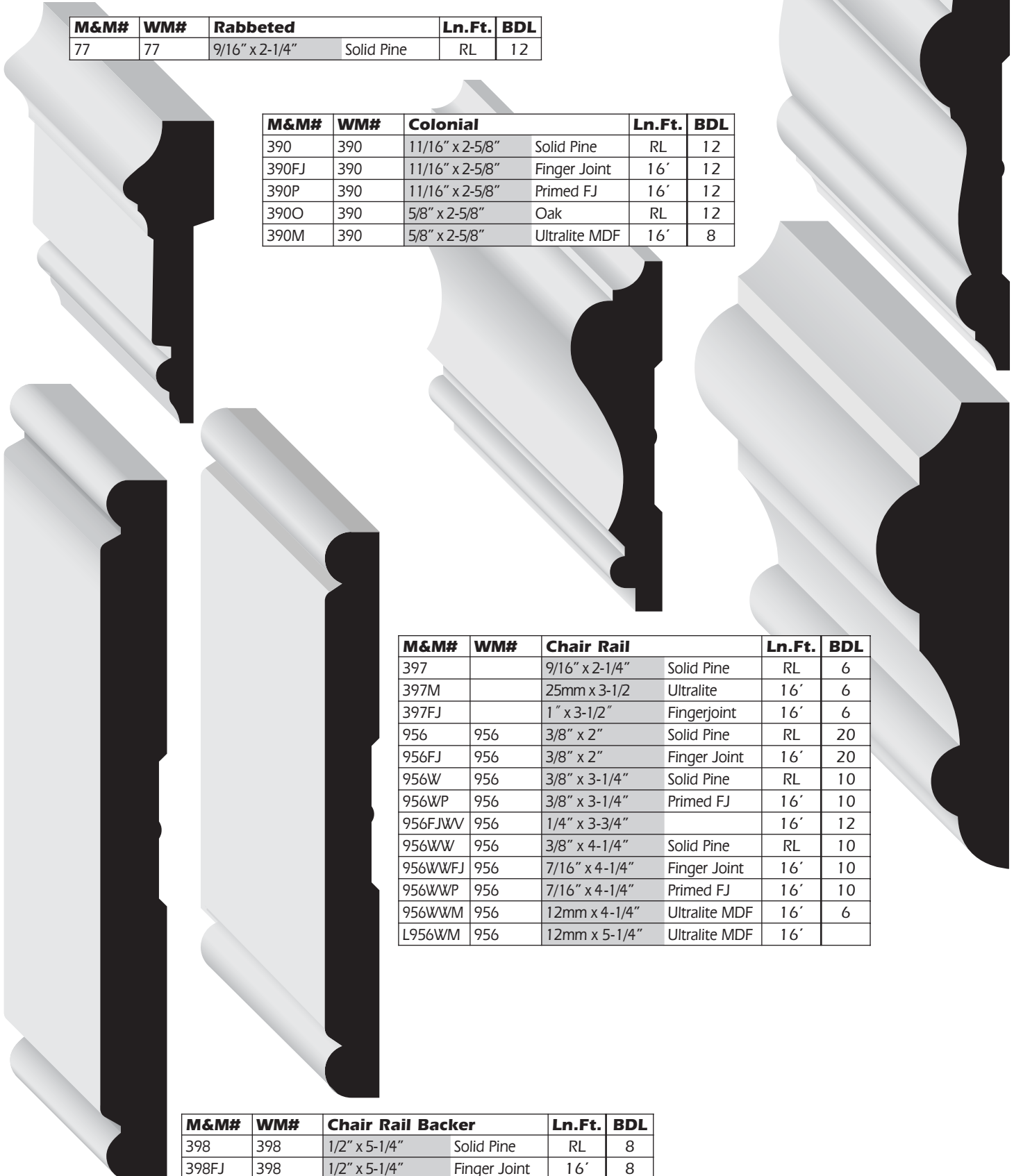

Chair Rails & Backers

Chair rails have a decorative and practical function. Applied to a wall anywhere from 24 to 48 inches from the floor, they are a beautiful accent to the room, while also protecting the wall from scuffs and dents from the backs of chairs.

ALL SIZES NOMINAL

M&M#	WM#	Camel Back		Ln.Ft.	BDL
302	302	1-1/16" x 2-3/4"	Solid Pine	RL	5
302FJ	302	1-1/16" x 2-3/4"	Finger Joint	16'	5
302P	302	1-1/16" x 2-3/4"	Primed FJ	16'	5

M&M#	WM#	Reeded		Ln.Ft.	BDL
227	227	9/16" x 2-1/2"	Solid Pine	RL	8
227P	227	9/16" x 2-1/2"	Primed FJ	16'	12

M&M#	WM#	Chair Rail		Ln.Ft.	BDL
300	300	1-1/16" x 3"	Solid Pine	RL	6
300FJ	300	1-1/16" x 3"	Finger Joint	16'	5
300P	300	1-1/16" x 3"	Primed FJ	16'	6
300M	300	25mm x 3"	Ultralite MDF	16'	3
300LFJ	300	1-1/16" x 3-1/8"	Finger Joint	16'	6

M&M#	WM#	Rabbeted		Ln.Ft.	BDL
133	133	1 1/16" x 1-3/4"	Solid Pine	RL	20

M&M#	WM#	Rabbeted		Ln.Ft.	BDL
301	301	1-1/16" x 3-3/8"	Solid Pine	RL	6

M&M#	WM#	Bubble		Ln.Ft.	BDL
303	L303	1-1/16" x 2-1/4"	Solid Pine	RL	8

M&M#	WM#	Flat		Ln.Ft.	BDL
224	224	9/16" x 2-1/2"	Solid Pine	RL	12
224P	224	9/16" x 2-1/2"	Primed FJ	16'	12

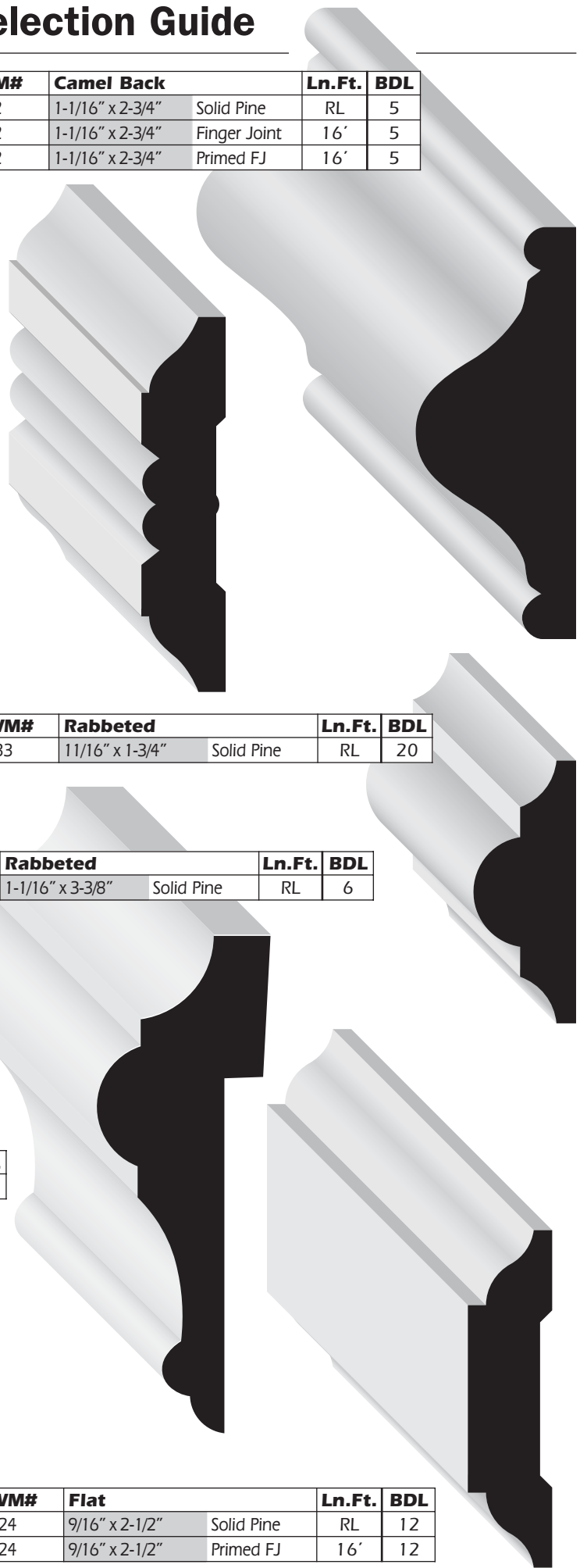

Rakes

ALL SIZES NOMINAL

M&M#	WM#	Rake Mould	Ln.Ft.	BDL
210	210	11/16" x 1-5/8" Solid Pine	RL	20
210P	210	11/16" x 1-5/8" Primed FJ	16'	20
PVC210	210	11/16" x 1-5/8" PVC	16'	28



M&M#	WM#	Rake Mould	Ln.Ft.	BDL
286P	286	1-1/16" x 2" Primed FJ	16'	8

M&M#	WM#	Rake Mould	Ln.Ft.	BDL
WP286LP	L286	1-1/16" x 2" Primed FJ	16'	8

M&M#	WM#	Rake Mould	Ln.Ft.	BDL
1	1	3/4" x 1-1/2" Solid Pine	RL	10



M&M#	WM#	Rake Mould	Ln.Ft.	BDL
8	8	9/16" x 1-5/8" Solid Pine	RL	12



M&M#	WM#	Rake Mould	Ln.Ft.	BDL
287P	287	1-1/16" x 2" Primed FJ	16'	8
PVC287	287	1-1/16" x 2" PVC	16'	10

M&M#	WM#	Rake Mould	Ln.Ft.	BDL
212	212	11/16" x 2-1/2" Solid Pine	RL	12

Base Caps & Shoes

ALL SIZES NOMINAL

M&M#	WM#	Base Cap	Ln.Ft.	BDL
167	167	11/16" x 1-1/8" Solid Pine	RL	30
167FJ	167	11/16" x 1-1/8" Finger Joint	16'	30
167P	167	11/16" x 1-1/8" Primed FJ	16'	30
165	165	11/16" x 1-3/8" Solid Pine	RL	30

M&M#	WM#	Base Cap	Ln.Ft.	BDL
425	425	11/16" x 1-3/8" Solid Pine	RL	20

M&M#	WM#	Base Cap	Ln.Ft.	BDL
164	164	11/16" x 1-1/8" Solid Pine	RL	30
PVC164-16	164	11/16" x 1-1/8" PVC	16'	38

M&M#	WM#	Base Cap	Ln.Ft.	BDL
172	172	5/8" x 3/4" Solid Pine	RL	40

M&M#	WM#	Base Cap	Ln.Ft.	BDL
166	166	11/16" x 1-1/4" Solid Pine	RL	30
166P	166	11/16" x 1-1/4" Primed FJ	16'	30
166O	166	5/8" x 1-1/4" Oak	RL	30

M&M#	WM#	Base Cap	Ln.Ft.	BDL
426	426	11/16" x 1-1/8" Solid Pine	RL	25

M&M#	WM#	Shoe	Ln.Ft.	BDL
131JO	131	5/8" x 7/8" OG Oak	RL	30
131O	131	7/16" x 11/16" Oak	RL	30

M&M#	WM#	Base Cap	Ln.Ft.	BDL
161	161	9/16" x 11/16" Solid Pine	RL	40

M&M#	WM#	Shoes	Ln.Ft.	BDL
131	131	7/16" x 3/4" OG Solid Pine	RL	50
131O	131	7/16" x 11/16" OG Oak	RL	30

M&M#	WM#	Base Cap	Ln.Ft.	BDL
163	163	11/16" x 1-3/8" Solid Pine	RL	25
163FJ	163	11/16" x 1-3/8" Finger Joint	16'	25
163P	163	11/16" x 1-3/8" Primed FJ	16'	30
163O	163	5/8" x 1-3/8" Oak	RL	25
163M	163	18mm x 1-3/8" Ultralite MDF	16'	24

M&M#	WM#	Shoe	Ln.Ft.	BDL
125O	125	5/8" x 7/8" Oak	RL	25
126	126	1/2" x 3/4" Solid Pine	RL	50
126O	126	1/2" x 3/4" Oak	RL	30
126M	126	1/2" x 3/4" Mahogany	RL	50
126P	126	1/2" x 3/4" Primed FJ	RL	50
126F08	126	1/2" x 3/4" Solid Pine	8'	50
127	127	7/16" x 3/4" Solid Pine	RL	50
12708	127	7/16" x 3/4" Solid Pine	8'	50
PVC127-16	127	7/16" x 3/4" PVC	16'	50
127M	127	7/16" x 11/16" Ultralite	16'	50
127O	127	3/8" x 11/16" Oak	RL	50
127PFM	127	7/16" x 11/16" Mahogany		30
129	129	7/16" x 11/16" Solid Pine	RL	50
129P	129	7/16" x 11/16" Primed FJ	16'	50

Panel Moulds

Panel moulds are used to frame wall paneling and add a decorative element to this type of application. Panel moulds also add accent to walls.

ALL SIZES NOMINAL

M&M#	WM#	Panel	Ln.Ft.	BDL
173	173	1/4" x 1-3/8" Solid Pine	RL	40
173-8	173	1/4" x 1-3/8" Solid Pine	8'	40

M&M#	WM#	Panel	Ln.Ft.	BDL
137LFJ	137	9/16" x 1-1/4" Finger Joint	16'	30

M&M#	WM#	Panel	Ln.Ft.	BDL
989	989	3/8" x 1-5/8" Solid Pine	RL	20
989LFJ	989	3/8" x 1-1/8" Finger Joint	16'	40

M&M#	WM#	Panel	Ln.Ft.	BDL
183	183	9/16" x 1-1/8" Solid Pine	RL	40

M&M#	WM#	Panel	Ln.Ft.	BDL
186	L186	3/8" x 1-1/8" Solid Pine	RL	40

M&M#	WM#	Panel	Ln.Ft.	BDL
3		11/16" x 1-1/2" Solid Pine	RL	30
3P		11/16" x 1-1/2" Primed FJ	16'	20

M&M#	WM#	Panel	Ln.Ft.	BDL
42FJ	42	1-1/16" x 1-5/8" Finger Joint	16'	12

M&M#	WM#	Panel	Ln.Ft.	BDL
184P	184	1/2" x 1-1/2" Primed FJ	16'	20

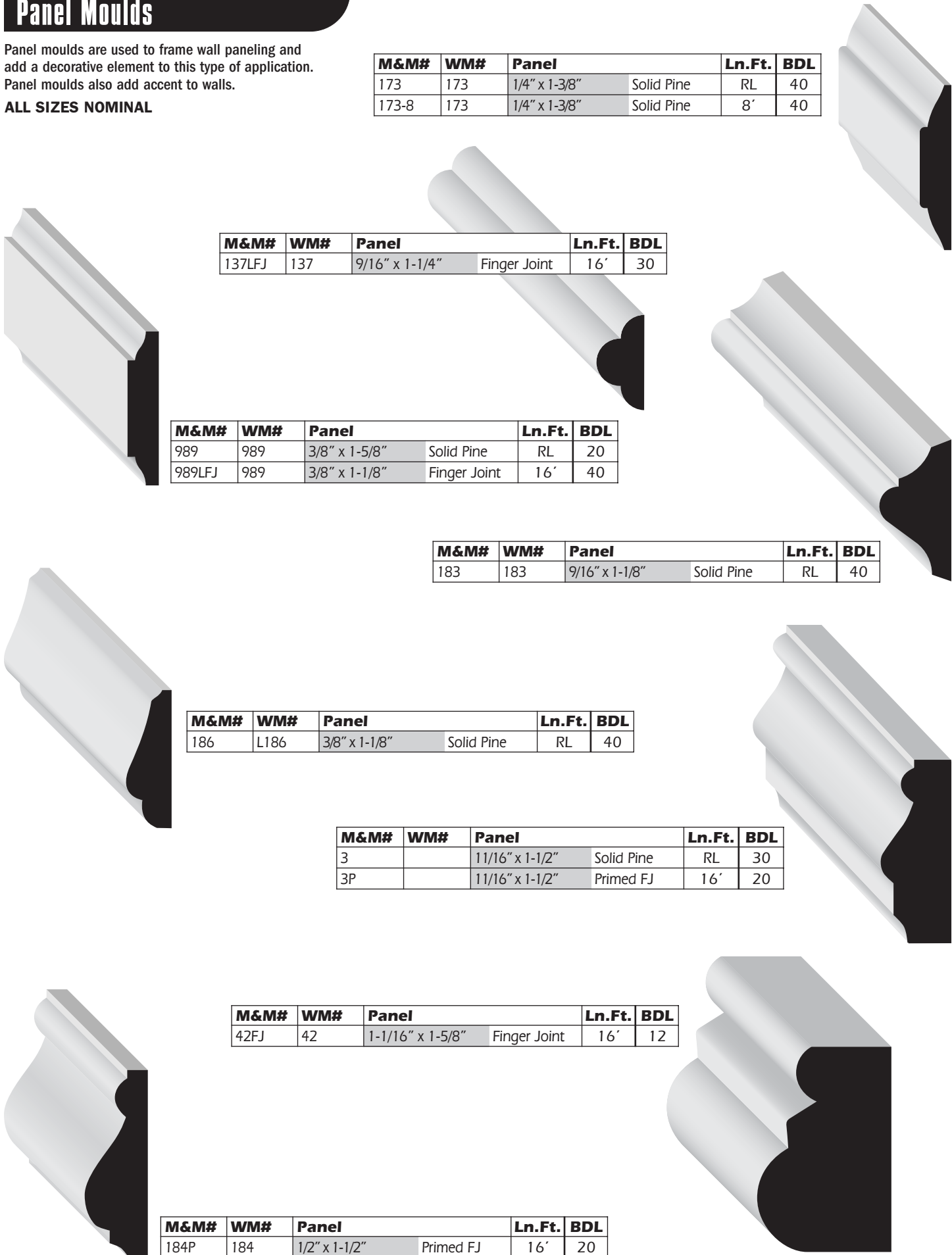

Mullions

ALL SIZES NOMINAL

M&M#	WM#	Backer/Mullion.	Ln.Ft.	BDL
956	956	3/8" x 2" Solid Pine	RL	20
956FJ	956	3/8" x 2" Finger Joint	16'	20

Note: 956W & 956WW shown with "Chair Rails & Backers"

M&M#	WM#	Mullion	Ln.Ft.	BDL
962	962	3/8" x 2" Solid Pine	RL	20

M&M#	WM#	O.G. Mullion	Ln.Ft.	BDL
982	982	3/8" x 2" Solid Pine	RL	20
983L	983	3/8" x 1-3/8" Solid Pine	RL	

M&M#	WM#	Backer/Mullion.	Ln.Ft.	BDL
987	987	3/8" x 2" Solid Pine	RL	20
987FJ	987	3/8" x 2" Finger Joint	16'	20

M&M#	WM#	Backer/Mullion.	Ln.Ft.	BDL
988L	988	3/8" x 1-5/16" Solid Pine	RL	30
988LFJ	988	3/8" x 1-5/16" Finger Joint	16'	30

M&M#	WM#	Mullion	Ln.Ft.	BDL
972		3/8" x 2" Solid Pine	RL	20

M&M#	WM#	O.G. Mullion	Ln.Ft.	BDL
959	959	3/8" x 1-1/8" Solid Pine	RL	30

M&M#	WM#	Mullion	Ln.Ft.	BDL
WP973P	973	3/8" x 1-1/2" Primed FJ	16'	30
WP973WP	973	3/8" x 3-1/4" Primed FJ	16'	10

M&M#	WM#	Mullion	Ln.Ft.	BDL
958	958	3/8" x 1-1/2" Solid Pine	RL	30
958FJ	958	3/8" x 1-1/2" Finger Joint	16'	30

Bricks

BRICKMOULDS: Brickmoulds are used as exterior casing around doors.

ALL SIZES NOMINAL

M&M#	WM#	Beaded	Ln.Ft.	BDL
175P	175	1-1/4" x 2" Primed FJ		

M&M#	WM#	Brick Mould	Ln.Ft.	BDL
180	180	1-1/4" x 2" Solid Pine	RL	8
180P	180	1-1/4" x 2" Primed FJ	16'	8
180F	180	1-1/4" x 2" Fir	RL	8
180FJ	180	1-1/4" x 2" Finger Joint	16'	8
PVC180	180	1-1/4" x 2" PVC	18'	

PVC180 Available as 7' pieces.

Door Stops

Stops are used in door and window applications to “stop” the door or window. Stops come in a wide range of widths in single bullnose (one eased edge) or double bullnose (two eased edges).

ALL SIZES NOMINAL



M&M#	WM#	Clam Stop		Ln.Ft.	BDL
855	855	3/8" x 1-5/8"	Solid Pine	RL	30
856	856	3/8" x 1-3/8"	Solid Pine	RL	30
856FJ	856	3/8" x 1-3/8"	Finger Joint	16'	30
856F07	856	3/8" x 1-3/8"	Solid Pine	7'	30
856P	856	3/8" x 1-3/8"	Primed FJ	16'	30
856PF07	856	3/8" x 1-3/8"	Primed FJ	7'	30
856OF07	856	3/8" x 1-3/8"	Oak	7'	30
858	858	3/8" x 1-1/8"	Solid Pine	RL	40
858P	858	3/8" x 1-1/8"	Primed FJ	16'	40

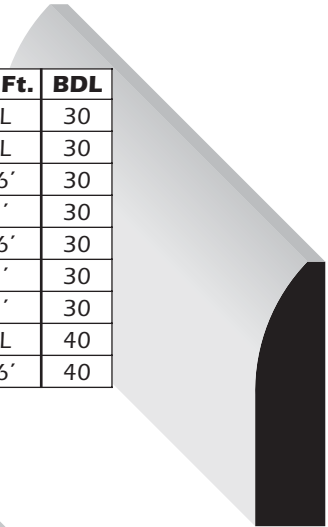

M&M#	WM#	Colonial O.G.		Ln.Ft.	BDL
936	936	7/16" x 1-3/8"	Solid Pine	RL	30
936F07	936	7/16" x 1-3/8"	Solid Pine	7'	30

M&M#	WM#	Colonial O.G.		Ln.Ft.	BDL
945	945	3/8" x 1-5/8"	Solid Pine	RL	30
946	946	3/8" x 1-3/8"	Solid Pine	RL	30
946F07	946	3/8" x 1-3/8"	Solid Pine	7'	30
946MF07	946	3/8" x 1-3/8"	Ultralite MDF	7'	30
946FJ	946	3/8" x 1-3/8"	Finger Joint	16'	30
946FJ07	946	3/8" x 1-3/8"	Finger Joint	7'	30
946P	946	3/8" x 1-3/8"	Primed FJ	16'	30
946PF07	946	3/8" x 1-3/8"	Primed FJ	7'	30
947	947	3/8" x 1-1/4"	Solid Pine	RL	30
947F07	947	3/8" x 1-1/4"	Solid Pine	7'	30
947O	947	3/8" x 1-1/4"	Oak	RL	20
947OF07	947	3/8" x 1-1/4"	Oak	7'	20
948	948	3/8" x 1-1/8"	Solid Pine	RL	40
948P	948	3/8" x 1-1/8"	Primed FJ	16'	40
948FJF07	948	3/8" x 1-1/8"	Finger Joint	7'	40
950	950	3/8" x 7/8"	Solid Pine	RL	50
951	951	3/8" x 3/4"	Solid Pine	RL	50
952	952	3/8" x 5/8"	Solid Pine	RL	50



M&M#	WM#	Round Edge/Batten		Ln.Ft.	BDL
885	885	3/8" x 1-5/8"	Solid Pine	RL	30
886	886	3/8" x 1-3/8"	Solid Pine	RL	30
886F07	886	3/8" x 1-3/8"	Solid Pine	7'	30
886FJ	886	3/8" x 1-3/8"	Finger Joint	16'	30
886P	886	3/8" x 1-3/8"	Primed FJ	16'	30
886PF07	886	3/8" x 1-3/8"	Primed FJ	7'	30
887O	887	3/8" x 1-1/4"	Oak	RL	30
887PF07	887	3/8" x 1-1/4"	Primed FJ	7'	30
888	888	3/8" x 1-1/8"	Solid Pine	RL	40
888FJF07	888	3/8" x 1-1/8"	Finger Joint	7'	40
888FJF07R2E	888	3/8" x 1-1/8"	Finger Joint	7'	40
888PF07	888	5/16" x 1-1/8"	Finger Joint	7'	40
888PF07R2E	888	3/8" x 1-1/8"	Primed FJ	7'	40

Lattice

LATTICE: Lattice strips are thin pieces of flat moulding that come in several widths and have a multitude of uses. Among the most common uses are to hide seams, edge trim, etc.

ALL SIZES NOMINAL



M&M#	WM#	Lattice		Ln.Ft.	BDL
268S	268	1/4" x 7/8"	Solid Pine	RL	50
268	268	1/4" x 1-1/8"	Solid Pine	RL	40
268F08	268	1/4" x 1-1/8"	Solid Pine	8'	40
267	267	1/4" x 1-3/8"	Solid Pine	RL	40
267P	267	1/4" x 1-3/8"	Primed FJ	16'	40
267F08	267	1/4" x 1-3/8"	Solid Pine	8'	30
266	266	1/4" x 1-1/2"	Solid Pine	RL	30
266F08	266	1/4" x 1-1/2"	Solid Pine	8'	30
266T	266	1/4" x 1-1/2"	Treated Pine	RL	30
266W	266W	1/4" x 1-5/8"	Solid Pine	RL	30
PVC266-16	266	1/4" x 1-1/2"	PVC	16'	40
265	265	1/4" x 1-3/4"	Solid Pine	RL	30
265O	265	1/4" x 1-3/4"	Oak	RL	30
265F08	265	1/4" x 1-3/4"	Solid Pine	8'	30
265XW	265	1/4" x 5-1/4"	Solid Pine	RL	10

PVC266 Also available as 8' pieces.

Beads

ALL SIZES NOMINAL

M&M#	WM#	Screen Bead	Ln.Ft.	BDL
142	142	1/4" x 3/4" Solid Pine	RL	50
142F08	142	1/4" x 3/4" Solid Pine	8'	50

M&M#	WM#	Parting Bead	Ln.Ft.	BDL
254	254	1/2" x 3/4" Solid Pine	RL	40
254F08	254	1/2" x 3/4" Solid Pine	8'	40
255P	255	9/16" x 9/16" Primed FJ	16'	50

M&M#	WM#	Screen Bead	Ln.Ft.	BDL
138	138	5/16" x 5/8" Solid Pine	RL	50

M&M#	WM#	Screen Bead	Ln.Ft.	BDL
522	522	1/2" x 3/4" Solid Pine	RL	40

M&M#	WM#	Screen Bead	Ln.Ft.	BDL
144	144	1/4" x 3/4" Solid Pine	RL	50

M&M#	WM#	Sash Bead	Ln.Ft.	BDL
953	953	1/2" x 7/8" Solid Pine	RL	30
953F08	953	1/2" x 7/8" Solid Pine	8'	30
953W	953	5/8" x 7/8" Solid Pine	16'	20
953S	953	7/16" x 1-1/8" Solid Pine	RL	40
953WW	953	1/2" x 7/8" Solid Pine	RL	30
953XW	953	7/16" x 1-5/8" Solid Pine	RL	20
954	954	1/2" x 1-1/8" Solid Pine	RL	50
954P	L954	7/16" x 1-3/8" Primed FJ	16'	50

M&M#	WM#	Solid Stop	Ln.Ft.	BDL
WP52	TWP52	3/4" x 1-1/8" Solid Pine	RL	30

M&M#	WM#	Glass Bead	Ln.Ft.	BDL
147	147	1/2" x 9/16" Solid Pine	RL	50
148	148	3/8" x 3/8" Solid Pine	RL	50

M&M#	WM#	Screen Bead	Ln.Ft.	BDL
249R		11/16" x 1-5/8" Solid Pine	RL	15

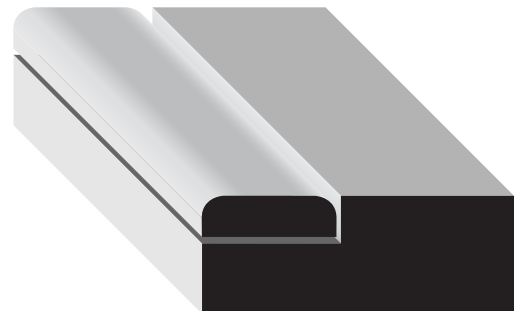
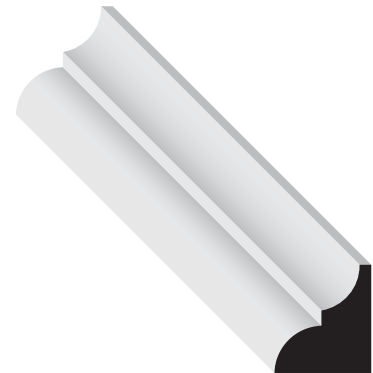
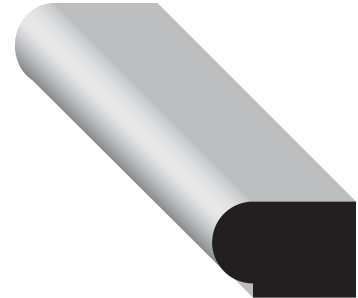
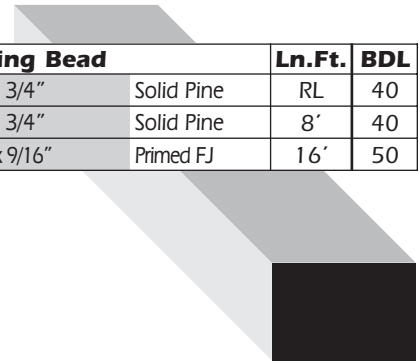
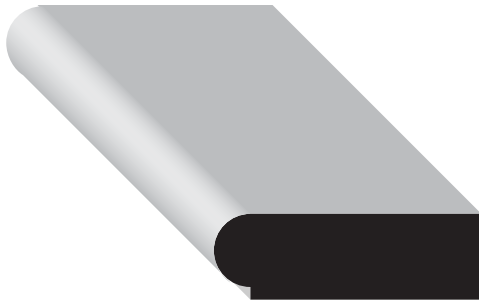
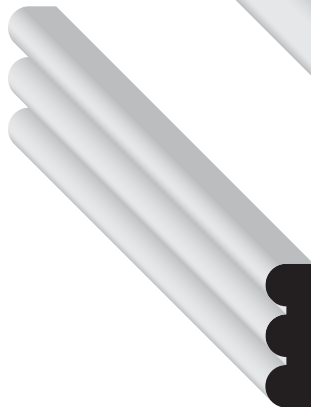
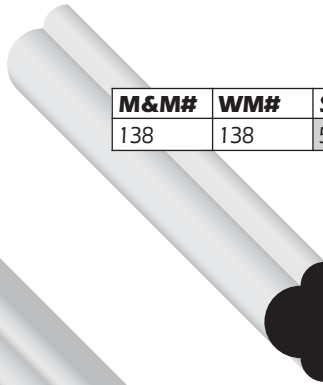
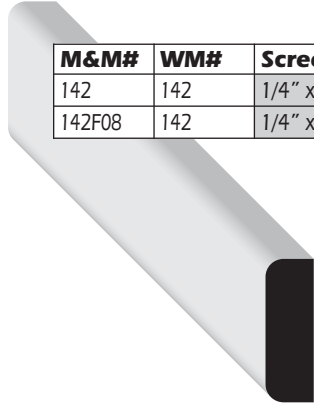

Corners

CORNERS: This profile is used to protect outside edges from damage and abrasion. Outside corners come in a variety of sizes and detail.

ALL SIZES NOMINAL

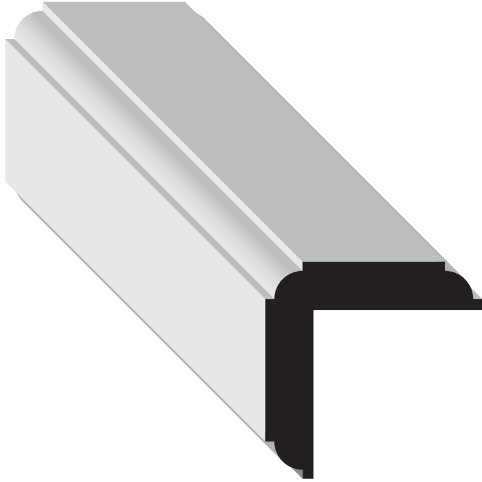

M&M#	WM#	Sanitary		Ln.Ft.	BDL
204	204	1-1/4" x 1-1/4"	Solid Pine	RL	20
204F08	204	1-1/4" x 1-1/4"	Solid Pine	8'	20
205	205	1-1/16" x 1-1/16"	Solid Pine	RL	20
205F08	205	1-1/16" x 1-1/16"	Solid Pine	8'	20
205OF08	205	1-1/8" x 1-1/8"	Oak	8'	20
206	206	3/4" x 3/4"	Solid Pine	RL	40
206F08	206	3/4" x 3/4"	Solid Pine	8'	40
206OF08	206	3/4" x 3/4"	Oak	8'	20

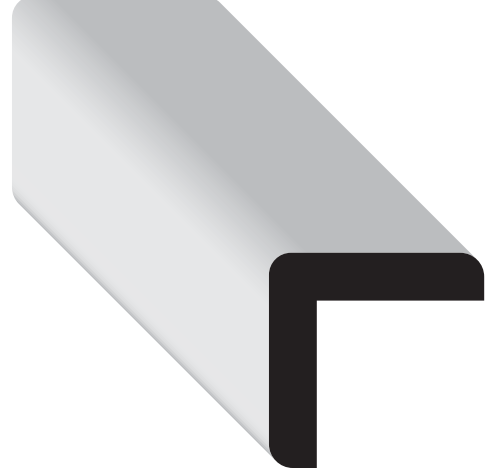

M&M#	WM#	Colonial		Ln.Ft.	BDL
201F08	201	1-1/4" x 1-1/4"	Solid Pine	8'	20
202F08	202	1-1/16" x 1-1/16"	Solid Pine	8'	20

Full Rounds, Half Rounds & Quarter Rounds

Rounds come in several sizes and serve a variety of functions.

ALL SIZES NOMINAL

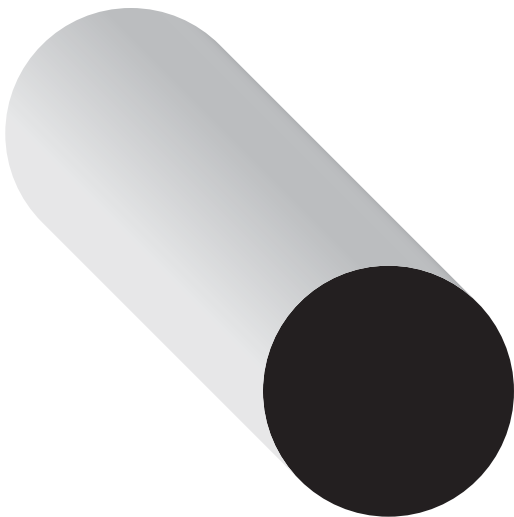

M&M#	WM#	Half Round		Ln.Ft.	BDL
120	120	1/2" x 1"	Solid Pine	16'	40
122	122	3/8" x 11/16"	Solid Pine	RL	50
123	123	5/16" x 5/8"	Solid Pine	RL	50
124	124	1/4" x 1/2"	Solid Pine	RL	50

M&M#	WM#	Quarter Round		Ln.Ft.	BDL
103	103	1-1/16" x 1-1/16"	Solid Pine	RL	20
104	104	11/16" x 1-3/8"	Solid Pine	RL	20
105	105	3/4" x 3/4"	Solid Pine	RL	40
106	106	11/16" x 11/16"	Solid Pine	RL	40
106F08	106	11/16" x 11/16"	Solid Pine	8'	40
106FJ	106	11/16" x 11/16"	Finger Joint	16'	40
106O	106	11/16" x 11/16"	Oak	RL	30
106P	106	11/16" x 11/16"	Primed FJ	16'	40
106OF08	106	11/16" x 11/16"	Oak	8'	30
108	108	1/2" x 1/2"	Solid Pine	RL	50
108F08	108	1/2" x 1/2"	Solid Pine	8'	50
109	109	3/8" x 3/8"	Solid Pine	RL	50
110	110	1/4" x 1/4"	Solid Pine	RL	50
110F08	110	1/4" x 1/4"	Solid Pine	8'	50

M&M#	WM#	Closet Pole/Round		Ln.Ft.	BDL
232H	232	1-9/16" - 6'+	Fir	16'	6
233H	233	1-1/4" - 6'+	Fir	16'	10
233R	233	1-1/4"	Solid Pine	RL	10

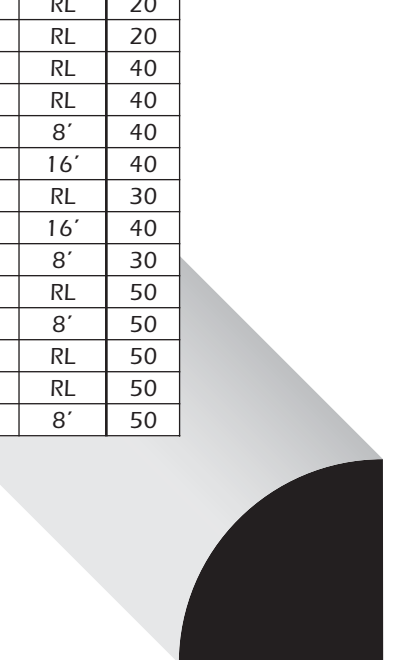
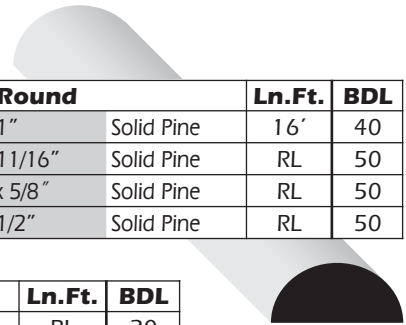

T-Astragals & Astragals

ALL SIZES NOMINAL

M&M#	WM#	Solid Flat Astragal	Ln.Ft.	BDL
133	133	1 1/16" x 1-3/4" Solid Pine	RL	20

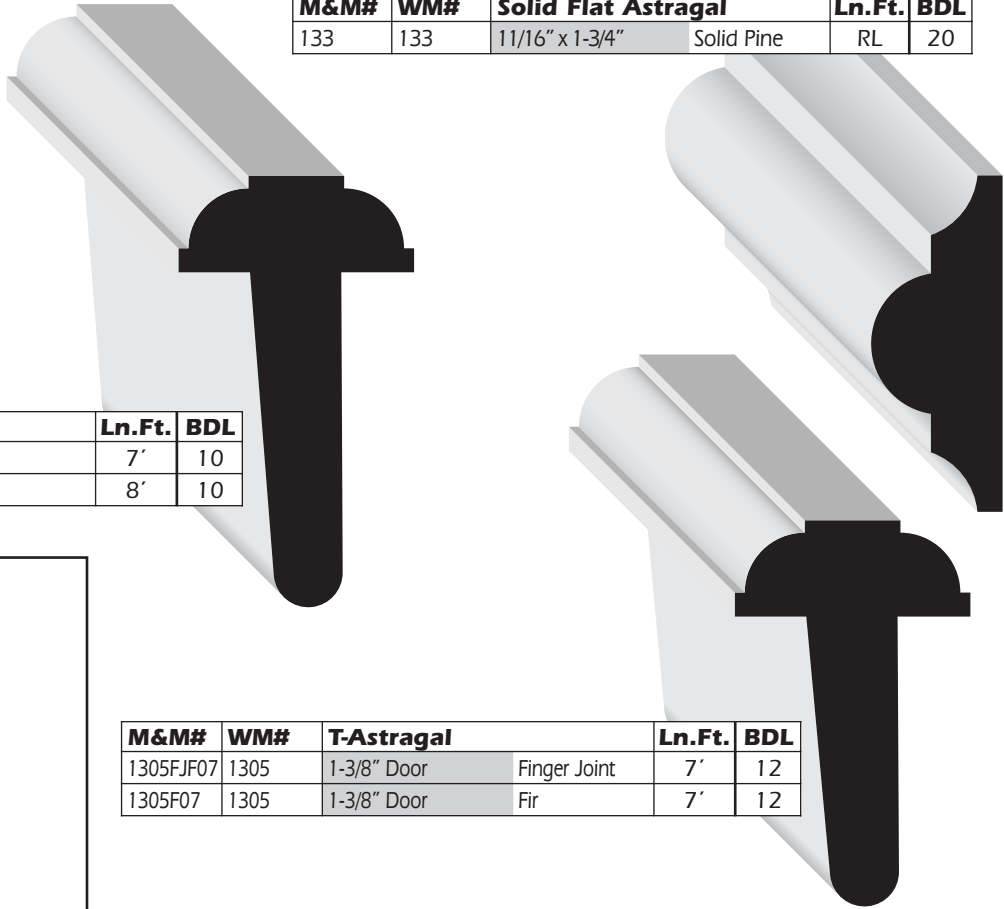

M&M#	WM#	T-Astragal	Ln.Ft.	BDL
1300F07	1300	1-3/4" Door Fir	7'	10
1300F08	1300	1-3/4" Door Fir	8'	10

Dentils

ALL SIZES NOMINAL

M&M#	WM#	T-Astragal	Ln.Ft.	BDL
1305FJF07	1305	1-3/8" Door Finger Joint	7'	12
1305F07	1305	1-3/8" Door Fir	7'	12

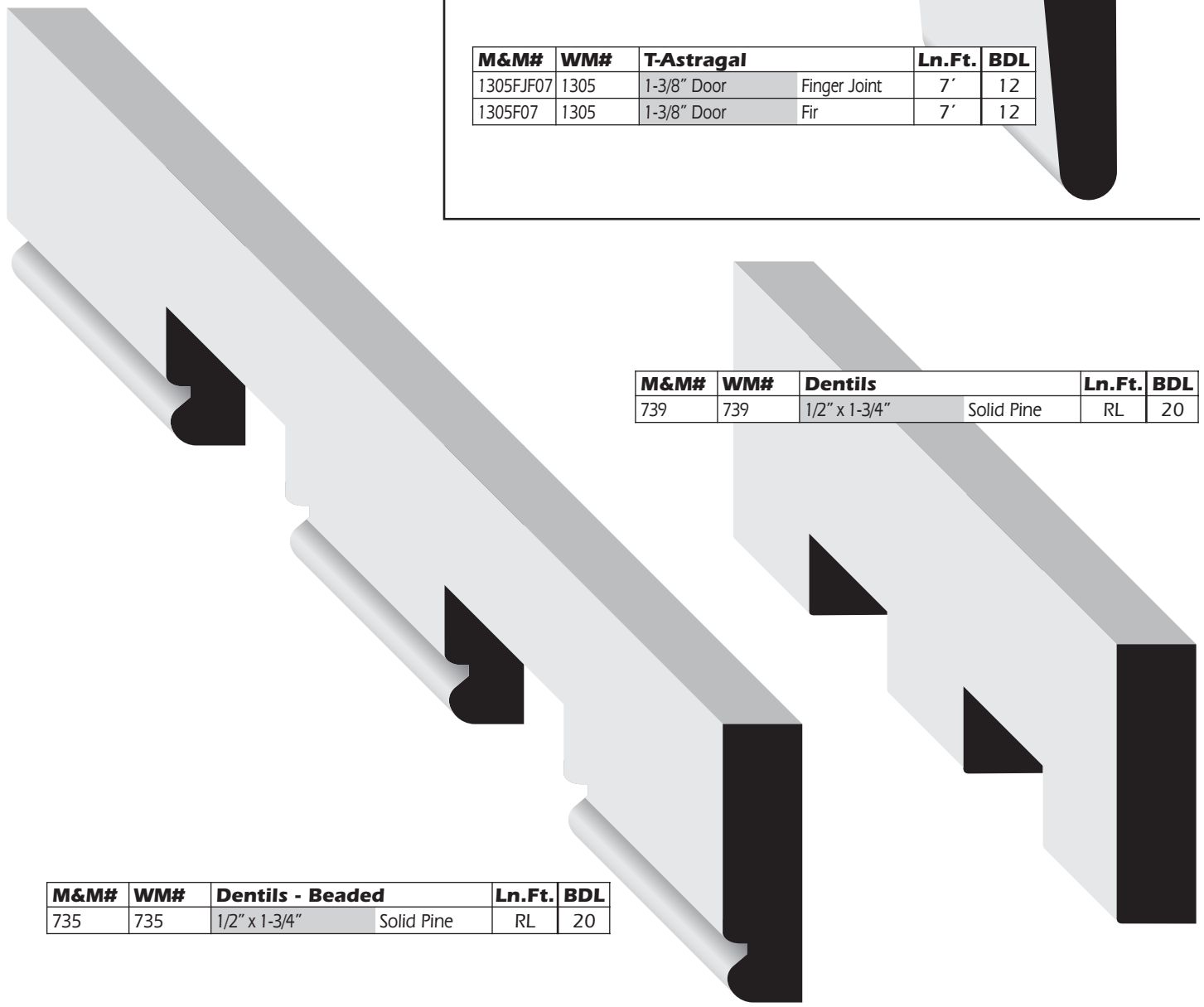

M&M#	WM#	Dentils	Ln.Ft.	BDL
739	739	1/2" x 1-3/4" Solid Pine	RL	20

M&M#	WM#	Dentils - Beaded	Ln.Ft.	BDL
735	735	1/2" x 1-3/4" Solid Pine	RL	20

Hand Rails

Handrails provide safety and support while going up or down stairs.

ALL SIZES NOMINAL

M&M#	WM#	Key Hole	Ln.Ft.	BDL
230R	230	1-3/8" x 1-11/16" Radiata	RL	6
230P	230	1-3/8" x 1-11/16" Primed FJ	16'	6
230H	230	1-1/2" x 1-11/16" Hemlock	RL	6

M&M#	WM#	Waterfall	Ln.Ft.	BDL
231R	231	1-1/2" x 1-11/16" Radiata	RL	6
231H	231	1-1/2" x 1-11/16" Hemlock	RL	6
231POP	231	1-3/8" x 1-1/16" Poplar	RL	4

M&M#	WM#	Oval	Ln.Ft.	BDL
240P	240	1-1/8" x 2-1/4" Primed FJ	16'	4
240H	240	1-1/4" x 2-1/4" Hemlock	RL	4
240R	240	1-1/4" x 2-1/4" Radiata	RL	6

Stair Moulds

ALL SIZES NOMINAL

M&M#	WM#	Hearth Strip	Ln.Ft.	BDL
1045O	1030	11/16" x 1-1/2" Oak	RL	10

M&M#	WM#	Nosing	Ln.Ft.	BDL
1030O	1030	1-1/16" x 1-1/4" Oak	RL	9
1030P	1030	1-1/16" x 1-1/4" Y.P	RL	12

M&M#	WM#	Landing Tread	Ln.Ft.	BDL
1060O	1060	1-1/16" x 3-1/2" Oak	RL	6
1060P	1060	1-1/16" x 3-1/2" Y.P	RL	6
1060W	1060	1-1/16" x 5-1/2" Oak	RL	6
1060WP	1060	1-1/16" x 5-1/2" Y.P	RL	6

M&M#	WM#	Scotia	Ln.Ft.	BDL
1075O	1075	1/2" x 3/4" Oak	RL	30

Extension Jamb & Screen Stock

ALL SIZES NOMINAL



M&M#	WM#			Ln.Ft.	BDL
1199	1199	21/32" x 2"	Solid Pine	RL	12
1199W	1199	21/32" x 4"	Solid Pine	RL	8



M&M#	WM#	Andersen Naroline Ext. Jamb		Ln.Ft.	BDL
1196S	1196S	11/16" x 2" S4S	Solid Pine	RL	12
1196SP	1196S	11/16" x 2" S4S	Primed FJ	16'	12

M&M#	WM#	S4S Screen Stock		Ln.Ft.	BDL
246	246	11/16" x 2-5/8"	Solid Pine	RL	10
246LP	246	11/16" x 2-3/4"	Primed FJ	16'	10
247	247	1/2" x 2"	Solid Pine	RL	10
249	249	11/16" x 1-5/8"	Solid Pine	RL	15
249-8	249	11/16" x 1-5/8"	Solid Pine	8'	15
249P	249	11/16" x 1-5/8"	Primed FJ	16'	15

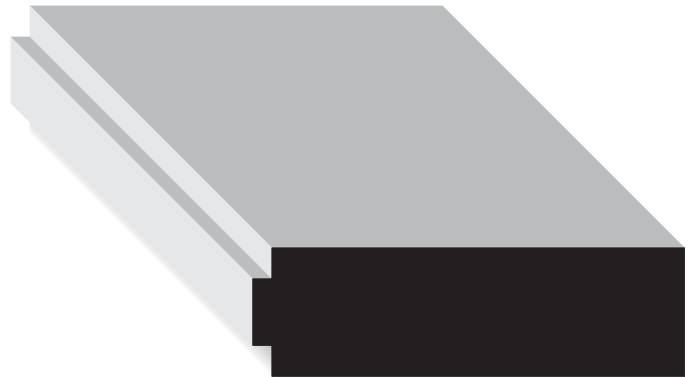

M&M#	WM#	Andersen Tilt/wash Ext. Jamb		Ln.Ft.	BDL
1196T	1196	11/16" x 2-3/16"	Solid Pine	RL	12



M&M#	WM#	Andersen Casement Ext. Jamb		Ln.Ft.	BDL
1196	1196	11/16" x 1-15/16"	Solid Pine	RL	6
1196P	1196	11/16" x 1-15/16"	Primed FJ	16'	6
1196W	1196	11/16" x 3-15/16"	Solid Pine	RL	8
1196WP	1196W	11/16" x 3-15/16"	Primed FJ	16'	8

Stools

ALL SIZES NOMINAL

M&M#	WM#	Andersen 200 T.H. Stool	Ln.Ft.	BDL
200P	200	11/16" x 2-1/2" Primed FJ	16'	8



M&M#	WM#	Rabbeted Stool	Ln.Ft.	BDL
1159	1159	1-1/16" x 5-1/4" - 1-1/4" Solid Pine	RL	4
1160	1160	1-1/16" x 4-1/4" - 1-1/4" Solid Pine	RL	4
1163	1163	1-1/16" x 3-1/4" - 1-1/4" Solid Pine	RL	6
1163FJ	1163	1-1/16" x 3-1/4" - 1-1/4" Finger Joint	16'	6
1163OD	1163	1-1/16" x 3-1/4" - 7/8" Solid Pine	RL	6
1164	1164	1-1/16" x 2-3/4" - 7/8" Solid Pine	RL	6
1164P	1164	1-1/16" x 2-3/4" Primed FJ	16'	8
1164FJ	1164	1-1/16" x 2-3/4" - 7/8" Finger Joint	16'	6
L1164P	L1164	1-1/16" x 2-1/8" Primed FJ	16'	6
1193	1193	11/16" x 3-1/4" - 1-1/4" Solid Pine	RL	12
1195	1195	11/16" x 2-1/2" - 7/8" Solid Pine	RL	12
1195P	1195	11/16" x 2-1/2" - 7/8" Primed FJ	16'	12
1195FJ	1195	11/16" x 2-1/2" Finger Joint	16'	12

M&M#	WM#	Andersen Tilt Wash Stool	Ln.Ft.	BDL
1197T		11/16" x 2-3/8" Solid Pine	RL	12
1197TP		11/16" x 2-3/8" Primed FJ	16'	12
1197WT		11/16" x 4-3/8" Solid Pine	RL	8
1197WTP		11/16" x 4-3/8" Primed FJ	16'	8



M&M#	WM#	Andersen Narrow Line Stool	Ln.Ft.	BDL
1197		11/16" x 2-3/8" Solid Pine	RL	12
1197FJ		11/16" x 2-3/8" Finger Joint	16'	12
1197P		11/16" x 2-3/8" Primed FJ	16'	12
1197TB		11/16" x 2-3/8" Solid Pine	RL	12
1197W		11/16" x 4-3/8" Solid Pine	RL	8
1197WP		11/16" x 4-3/8" Primed FJ	16'	8
1197B		11/16" x 4-3/8" Solid Pine	RL	12
1197WB		11/16" x 4-3/8" Solid Pine	RL	8
1197WTB		11/16" x 4-3/8" Solid Pine	RL	8



M&M#	WM#	Stool	Ln.Ft.	BDL
1020FJ	1020	1-1/16" x 5-1/4" Finger Joint	16'	6
1020P	1020	1-1/16" x 5-1/4" Primed FJ	16'	6
1021	1021	11/16" x 5-1/4" Solid Pine	RL	8
1021FJ	1021	11/16" x 5-1/4" Finger Joint	16'	8
1021P	1021	11/16" x 5-1/4" Primed FJ	16'	8
1021M	1021	15mm x 5-1/4" Ultralite MDF	16'	4
1021WFJ	1021	11/16" x 7-1/4" Finger Joint	16'	4
1021WP	1021	11/16" x 7-1/4" Primed FJ	16'	4
1021WM	1021	15mm x 7-1/4" Ultralite MDF	16'	4
1021LP	1021	11/16" x 3-1/2" Primed FJ	16'	8
1022P	L1022	11/16" x 4-1/2" Primed FJ	16'	6
1022M	1022	15mm x 4-1/2" Ultralite MDF	16'	4
1022FJ	1022	11/16" x 4-1/2" Finger Joint	16'	6



Exterior Door & Window Moulds

ALL SIZES NOMINAL

M&M#	WM#	Sill Nosing	Ln.Ft.	BDL
BMSN		1-3/4" x 1-1/4" Primed FJ	16'	6

M&M#	WM#	Drip Cap	Ln.Ft.	BDL
188	188	1-1/16" x 1-5/8" Solid Pine	RL	12
188P	188	1-1/16" x 1-5/8" Primed FJ	16'	12
PVC188	188	1-1/16" x 1-5/8" PVC	16'	20

M&M#	WM#	Ln.Ft.	BDL
PVC6830-16		1-3/8" x 1-5/8" PVC	16' 1

M&M#	WM#	Ln.Ft.	BDL
PVC311-16		1-5/8" x 1-1/2" PVC	16' 1

M&M#	WM#	Ln.Ft.	BDL
PVC319-16		5/8" x 3-1/2" PVC	16' 1

M&M#	WM#	Ln.Ft.	BDL
PVC6800-16		1-1/4" x 4-3/4" PVC	16' 1

M&M#	WM#	Sill	Ln.Ft.	BDL
1080P	1080	1-1/4" x 6-1/4" Primed FJ	16'	4

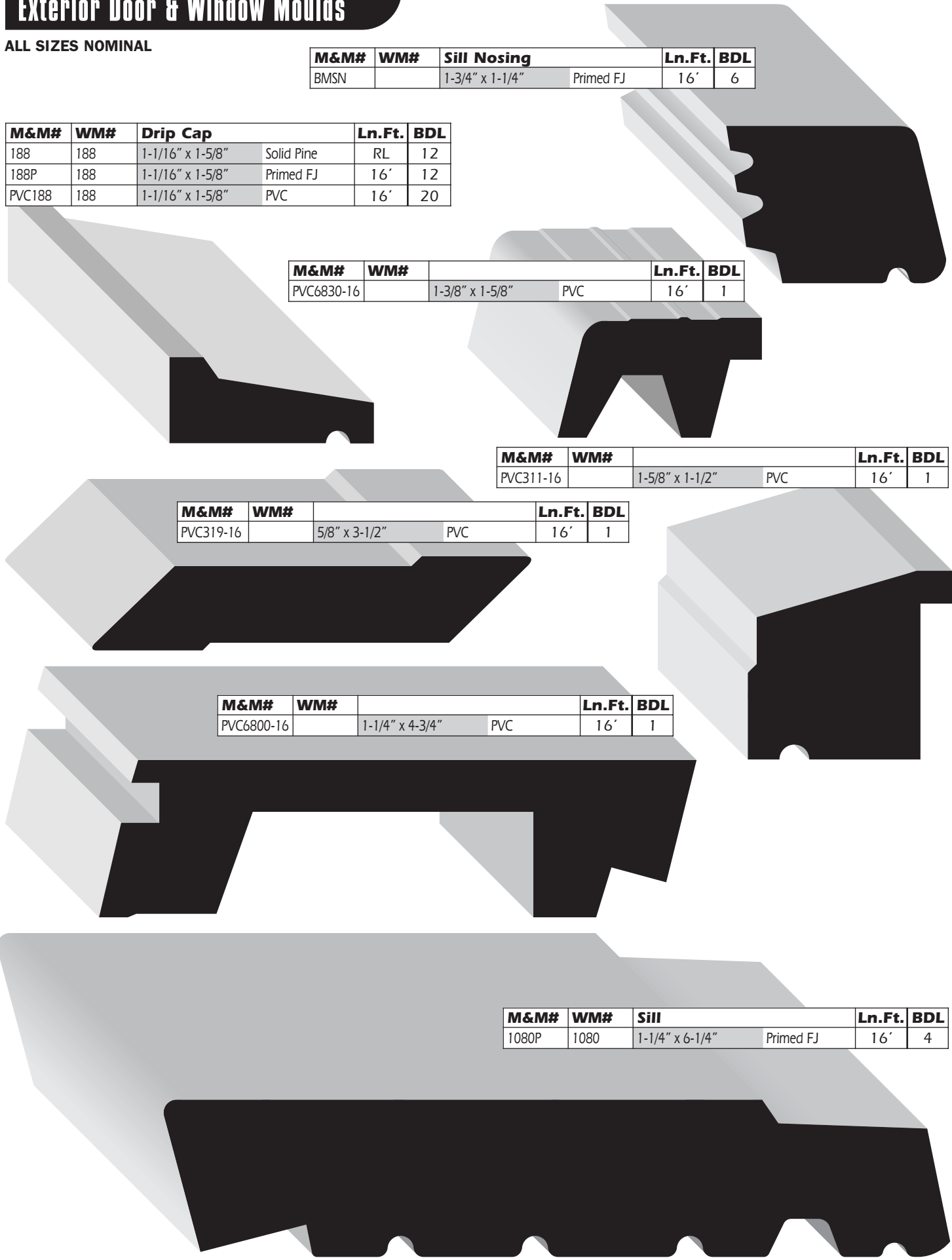

Rail Components - PVC

ALL SIZES NOMINAL

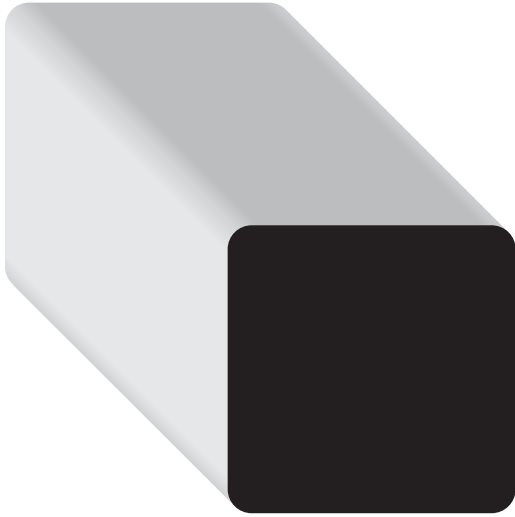

M&M#	WM#	Baluster	Ln.Ft.	BDL
PVC237		1-1/4" x 1-1/4" PVC	15'	0



M&M#	WM#	Bottom Rail	Ln.Ft.	BDL
PVC8842		1-3/4" x 3-1/2" PVC	16'	0

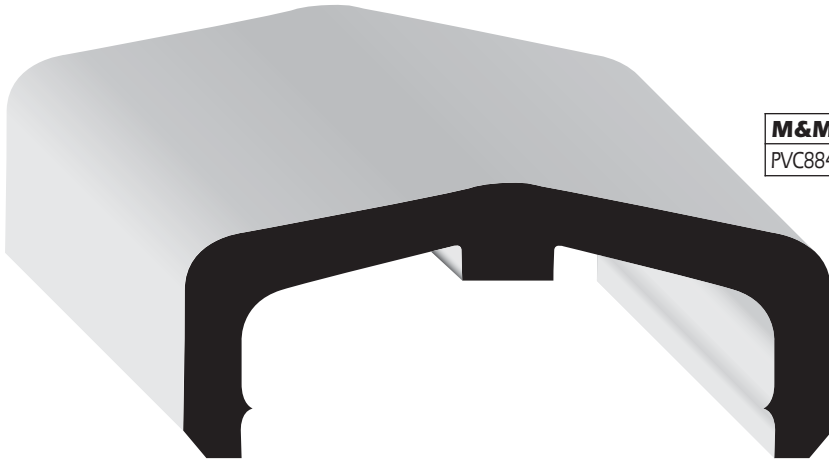

M&M#	WM#	Top Rail	Ln.Ft.	BDL
PVC8840		3-3/8" x 1-1/2" PVC	16'	0



M&M#	WM#	Filler PVC Top Rail	Ln.Ft.	BDL
8840F	8840FF	1" x 2-7/8" Fir, P.T. Primed	RL	6

M&M#	WM#	Filler PVC Bottom Rail	Ln.Ft.	BDL
8842F	8842FF	1-1/16" x 2-7/8" Fir, P.T. Primed	RL	6

Rail Components - Wood

ALL SIZES NOMINAL

M&M#	WM#	Top Rail		Ln.Ft.	BDL
8840	8840	1-1/2" x 3-1/2"	Fir	RL	6
8840P	8840	1-1/2" x 3-1/2"	Primed Fir	RL	6

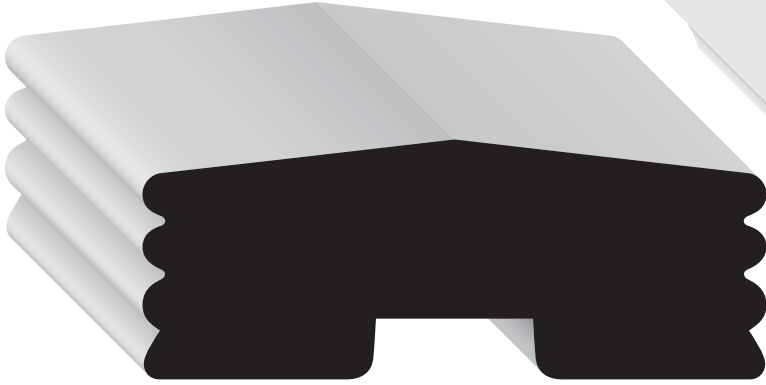

M&M#	WM#	Chester Top Rail		Ln.Ft.	BDL
8834LF	8840	1-3/16" x 1-7/8"	Fir	RL	8
8834F	8834	1-1/4" x 3-1/4"	Fir	RL	6

M&M#	WM#	Bottom Rail		Ln.Ft.	BDL
8841	8841	1-1/2" x 3-1/2"	Fir	RL	6
8841P	8841	1-1/2" x 3-1/2"	Primed Fir	RL	6

M&M#	WM#	Richmond Bottom Rail		Ln.Ft.	BDL
8835F	8835	1-1/4" x 3-1/4"	Fir	RL	6

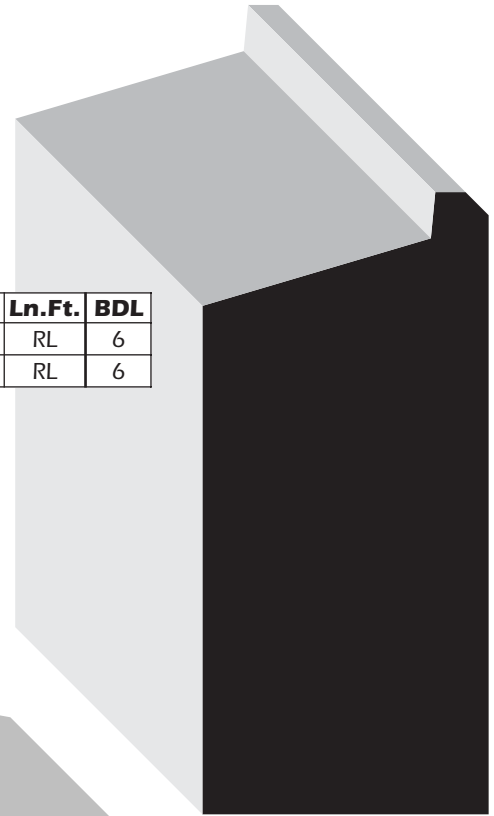

M&M#	WM#	Bottom Rail		Ln.Ft.	BDL
8838	8838	1-1/4" x 2-1/2"	Fir	RL	6



M&M#	WM#	Baluster		Ln.Ft.	BDL
236	236	1-1/2" x 1-1/2"	Fir	RL	6
237	237	1-1/4" x 1-1/4" E4E	Fir	RL	9
237P	237	1-1/4" x 1-1/4" E4E	Primed Fir	RL	9
237F	237	1-1/4" x 1-1/4"	Fir	RL	9
237FI31	237	1-1/2" x 1-1/2" x 31"	Fir	31"	PC
238	238	1-1/16" x 1-1/16"	Fir	RL	12
239	239	3/4" x 3/4"	Solid Pine	RL	30

Misc. Profiles

ALL SIZES NOMINAL

M&M#	WM#	Wainscot		Ln.Ft.	BDL
M1090	1090	3/8" x 3"	Fir	RL	16
LPVC1090	1090	5/8" x 5-1/2"	PVC	16'	6



M&M#	WM#	Wainscot		Ln.Ft.	BDL
222M	222	3/8" x 5-3/4"	Ultralite MDF	16'	1

M&M#	WM#	Mantel		Ln.Ft.	BDL
7P	7	1-3/8" x 5-3/8"	Primed FJ	16'	4

M&M#	WM#	Lip		Ln.Ft.	BDL
531	531	11/16" x 1-3/8"	Solid Pine	RL	12

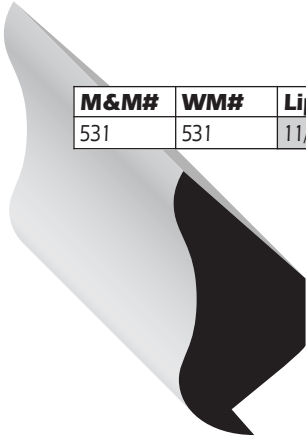

M&M#	WM#	Mantel		Ln.Ft.	BDL
225	225	1-3/8" x 3-5/8"	Solid Pine	RL	8

M&M#	WM#	Lip		Ln.Ft.	BDL
146	146	3/4" x 3/4"	Solid Pine	RL	40

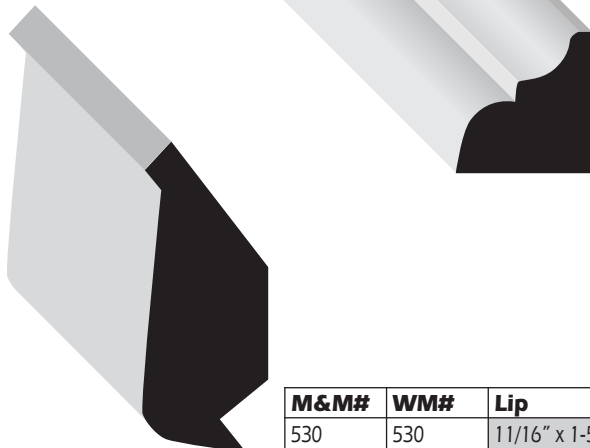

M&M#	WM#	Lip		Ln.Ft.	BDL
530	530	11/16" x 1-5/8"	Solid Pine	RL	20



Misc. Profiles

ALL SIZES NOMINAL

M&M#	WM#	Picture Moulding	Ln.Ft.	BDL
276	L276	11/16" x 1-3/4" Solid Pine	RL	20

M&M#	WM#	Cap	Ln.Ft.	BDL
1219	1219	11/16" x 1-9/16" Solid Pine	RL	30

M&M#	WM#	Ply Cap	Ln.Ft.	BDL
295	295	9/16" x 1-3/16" Solid Pine	RL	30

M&M#	WM#	Cap	Ln.Ft.	BDL
292	292	9/16" x 1-1/8" Solid Pine	RL	40

M&M#	WM#	Backband	Ln.Ft.	BDL
282M	282	1-1/8" x 1-9/16" Ultralite MDF	16'	9

M&M#	WM#	Cap	Ln.Ft.	BDL
290	290	11/16" x 1-3/8" Solid Pine	RL	25

M&M#	WM#	Wainscot Plycap	Ln.Ft.	BDL
850M	850	1-1/8" x 1-3/4" Ultralite MDF	16'	8

M&M#	WM#	Backband	Ln.Ft.	BDL
280	280	11/16" x 1-1/8" Solid Pine	RL	30

M&M#	WM#	Backband	Ln.Ft.	BDL
281	281	11/16" x 1-1/8" Solid Pine	RL	30

M&M#	WM#	Backband	Ln.Ft.	BDL
97BB	97	1-1/16" x 1-3/8" Solid Pine	RL	12

Misc. Profiles

ALL SIZES NOMINAL

M&M#	WM#	Architrave	Ln.Ft.	BDL
5030M		1-3/16" x 6-1/4" Ultralite MDF	16'	2



M&M#	WM#	Architrave	Ln.Ft.	BDL
5010M		1-3/16" x 4-1/4" Ultralite MDF	16'	4



M&M#	WM#	Threshold	Ln.Ft.	BDL
1040O	1040	5/8" x 3-1/2" Oak	RL	4

M&M#	WM#	Champher	Ln.Ft.	BDL
995	995	3/4" x 3/4" Solid Pine	RL	50
996	L995	1" x 1" Solid Pine	RL	30

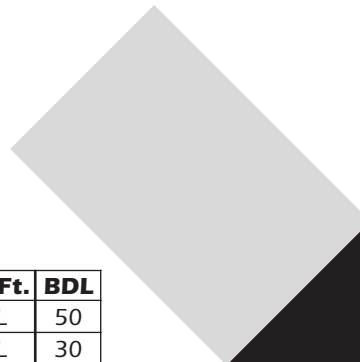

S4S Lumber

Finish boards come in S4S (surfaced four sides) and are used for a multitude of purposes including shelving, window liner, bases, casing, etc.

ALL SIZES NOMINAL

Solid Pine • Primed Fingerjoint •
Ultralite Supercoat MDF • PVC • OAK

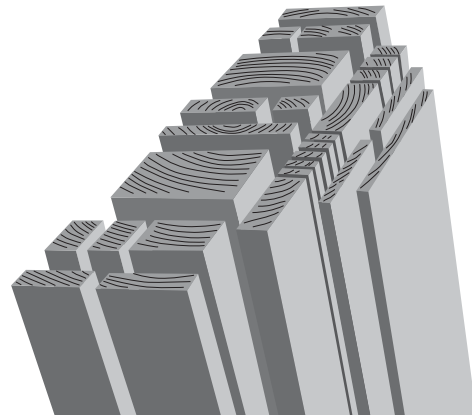

	1x4	1x6	1x8	1x10	1x12	5/4x4	5/4x6	5/4x8	5/4x10	5/4x12
SOLID POPLAR	X	X	X	X	X					
SOLID PINE	X	X	X	X	X					
PRIMED FJ PINE	X	X	X	X	X	X	X	X	X	X
FINGER JOINT POPLAR	X	X	X	X	X					
ULTRA-LITE MDF PRIMED	X	X	X	X	X					
OAK	X	X	X	X	X					

Also available in requested lengths.
Talk to a sales representative for more information.

Interior Jamb

Flat Jamb - Flat stock, usually eased on two edges, which surrounds a door or window and secures it in the rough opening. These jambs are available cut to length and lineal.

Split Jamb - A two piece jamb consisting of rabbeted and adjusting jamb sections for walls of varying thickness.

ALL SIZES NOMINAL

	FLAT JAMBS				SPLIT JAMBS			
	4-5/8	4-7/8	5-1/4	6-5/8	3-5/8	4-5/8	5-1/4	6-5/8
PINE VENEER PAIRS	X			X				
PRIMED FJ PAIRS	X					X		
RAW FJ PAIRS	X	X		X	X	X	X	X
RAW FJ LINEAL	X			X				
PRIMED FJ LINEAL	X							

Door Frame Stock

Flat Stock, most often rabbeted used in the hanging of exterior doors.

ALL SIZES NOMINAL

Exterior 1-1/4" thickness w/ 1-3/4 Rab. No Kerf.

	4-5/8	5-1/4	6-1/2
PRIMED FJ Lineal	X	X	X

Cased Openings

Pre-packaged interior mouldings and jamb required to case a particular rough door opening.

ALL SIZES NOMINAL

376FJ 11/16" X 4-5/8"	2/0 X 6/8	2/6 X 6/8	3/0 X 6/8	4/0 X 6/8	5/0 X 6/8	6/0 X 6/8
FINGER JOINT	X	X	X	X	X	X

Accessories

M&M#	WM#	Plinth Blocks	
PB4P4		1-1/8" x 3-1/2" x 7"	OG Pine Plinth Block
PB4		1-1/8" x 3-1/2" x 7-1/4"	Pine Plinth Block
PB4O		3-1/2" x 8"	Oak Plinth Block
PB5O		4-5/8"	Oak Plinth Block
PB5M		1/2" x 4-5/8" x 8"	Primed MDF Plinth Block
PB4P4M		1-1/8" x 3-1/2" x 7"	Primed MDF Plinth Block
P4M		1-1/8" x 3-1/2" x 7-1/4"	Primed MDF Plinth Block
PB358M		7/8" x 3-5/8" x 9"	Primed MDF Colonial Plinth
PB375M		1" x 3-3/4" x 9"	Primed MDF Victorian Plinth



M&M#	WM#	Rosettes, Blocks & Corners	
R275		7/8" x 2-3/4"	Pine Rosette
R375		1-1/16" x 3-3/4"	Pine Rosette w/edge
R375PL		1-1/16" x 3-3/4"	Pine Rosette plain
R3A1		7/8" x 2-1/2"	Pine Rosette w/edge
R4A1		7/8" x 3-1/2"	Pine Rosette w/edge
R4PL		7/8" x 3-1/2"	Pine Rosette plain
R4S		7/8" x 3-3/4"	Pine Rosette
R5-5		1-1/8" x 5-1/2"	Pine Bullseye Rosette
R5A1		7/8" x 4-5/8"	Pine Rosette w/edge
R6A1		7/8" x 5-3/4"	Pine Rosette w/edge
R9A1		1-5/16" x 3-7/8"	Pine Rosette
R2O		3/4" x 2-3/4"	Oak Rosette
R3O		2-1/2"	Oak Rosette Corner Block
R4O		3-1/2"	Oak Rosette Corner Block
R9O		1-1/8" x 3-7/8"	Oak Rosette
R9A1M		1-5/16" x 3-7/8"	Primed MDF Rosette
R375M		7/8" x 3-1/2"	Primed MDF Rosette
R5A1M		7/8" x 4-5/8"	Primed MDF Rosette
R350M		7/8" x 3-1/2"	Primed MDF Rosette
R250M		7/8" x 2-1/2"	Primed MDF Rosette
R375VM		1" x 3-3/4"	Primed MDF Victorian Corner Blk.
BB15M		7/8" x 7/8" x 9"	Primed MDF Outside Corner
BBO5M		1-1/4" x 1-1/4" x 9"	Primed MDF Outside Base Corner

Flexible Mouldings

BY:



WE HAVE A LARGE SELECTION OF FLEXIBLE MOULDINGS IN STOCK MOULDED TO MATCH MOST M&M PROFILES. ALSO, THE ABILITY TO PRODUCE ANY PATTERN CUSTOM FIT TO YOUR SPECIFICATIONS

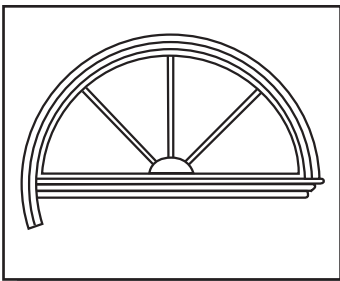
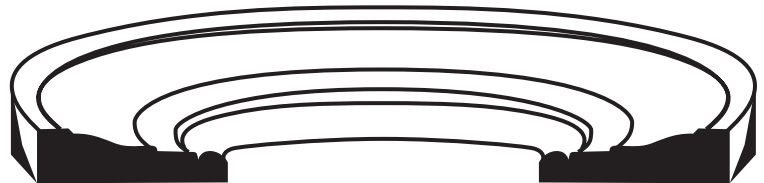

True Radius Round Top Half Circle Casing

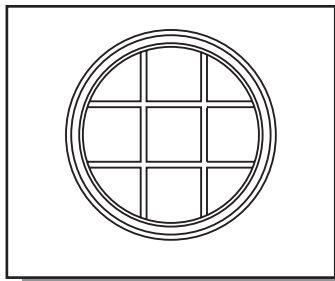

True Radius Full Circle Casing

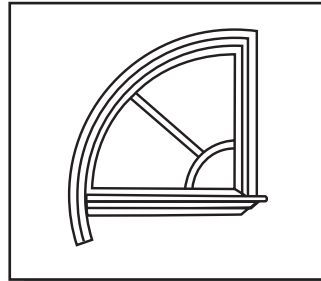

True Radius Quarter Circle Casing

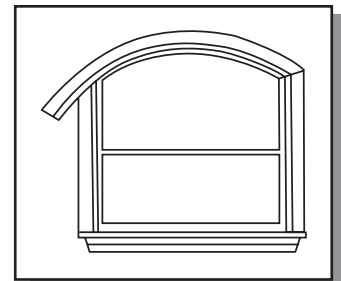

ARC Eyebrow Segment Casing

What if...
Thoughts became Expectations



What if...
Dreams became Reality

What if...
Expectations became Dreams



What if...
You put it all Together..

...and Made Your Dreams Come True!

MOULDING & MILLWORK - MID ATLANTIC LOCATIONS

BALTIMORE

9325A Snowden River Parkway
Columbia, MD 21046

T: 410 423-2440 TF:1-800-638-1920
F: 410 423-2441

PITTSBURGH

Box 756 Wimmerton Ind. Park
Building 2 Sec. B, Devereaux Drive
Latrobe, PA 15650

T: 724 537-4772 TF:1-800-737-3665
F: 724 537-5168

BRIDGEVILLE

617 Market Street Unit #4
Bridgeville, DE 19933

T: 302 337-0269 TF:1-800-508-4288
F: 302 337-3050

RICHMOND

861 Liberty Way
Chester, VA 23836

T: 804 530-8530 TF:1-888-391-8006
F: 804 530-8535

PHILADELPHIA

31 Vanguard Drive Lincoln Corp. Centre
Reading, PA 19606

T: 610 404-2424 TF:1-800-537-8039
F: 610 404-2466

WINCHESTER

131 Kentmere Court
Winchester, VA 22603

T: 504 723-6440 TF:1-800-877-1797
F: 540 723-6689

MOULDING & MILLWORK

www.mouldingandmillwork.com